

Power Bank 600 Single and Parallel System 6kVA

User Manual

Version: V1.0

BOM: 50490209008

Vertiv Co provides customers with technical support. Users may contact the nearest Vertiv local sales office or service center.

@2017 Vertiv Co. All rights reserved. Vertiv and the Vertiv logo are trademarks or registered trademarks of Vertiv Co. All other names and logos referred to are trade names, trademarks or registered trademarks of their respective owners. While every precaution has been taken to ensure accuracy and completeness herein, Vertiv Co. assumes no responsibility, and disclaims all liability, for damages resulting from use of this information or for any errors or omissions. Specifications are subject to change without notice.

Vertiv Energy Pvt. Ltd., India

Address: Plot No. C-20, Road No. 19, Wagle Industrial Estate, Thane – 400 604, Maharashtra, India

Homepage: www.vertivco.com

Special Declaration

Personnel Safety

1. This product must be installed and commissioned by professional engineers of the manufacturer or its authorized agent. Failure to observe this could result in product malfunction or personnel safety risk.
2. Take the time to read this product manual and the safety precaution thoroughly before installing and commissioning this product. Failure to observe this could result in product malfunction or personnel safety risk.
3. This product is not intended for life support equipment application.
4. Never dispose of the internal or external battery of this product in a fire, as it may explode and jeopardize personnel safety when exposed to flame.

Product Safety

1. If this product will be stored or remain de-energized for a long period, it must be placed in a dry and clean environment within specified temperature range.
2. This product should be used in an appropriate operating environment. For details, refer to the section on the environmental requirement in this manual.
3. This product is not designed for application in an environment:
 - Where the temperature and relative humidity are outside the specifications
 - Subject to vibrations or shocks
 - Where conductive dusts, corrosive gases, salts, or flammable gases are present
 - Near heat sources or strong electromagnetic interferences

Disclaimer

Vertiv disclaims any and all responsibility or liability for the defects or malfunction caused by:





- Application range or operating environment outside the specifications
- Unauthorized modification, improper installation or operation
- Force majeure
- Other actions not in compliance with the instructions in this manual

Application Note:

Power Bank 600 UPS is suitable for IT load applications such as computers, servers, routers, CCTV, banking automation equipments, scientific equipments, projector, POS, etc. The UPS is suitable for industrial customer for above load and UPS should be installed in AC environment. The UPS is not suitable for industrial load such as motors, drives, lift, PLC, DCS, SCADA, etc.

Safety Precaution

Always observe the following safety symbols!

| Safety symbol | Explanation |
|--|---|
|  Warning | Used for instructions intended to alert the user to the risk of death or severe injury should the unit be used improperly |
|  Note  Caution | Used for instructions intended to alert the user to the risk of injury or equipment damage should the unit be used improperly |
|  Important | Used for instructions intended to notify the user to carefully read and observe this unit though it may not cause damage |

This manual contains information concerning the installation and operation of the Power Bank 600 single UPS module and parallel system 6 kVA.

Read this manual thoroughly before installing, using and servicing the UPS.

 **Important**

The UPS with standard configuration is a category C3 product for commercial and industrial application in the second environment. Installation restrictions or additional measures may be needed to prevent disturbances.

 **Important**

The UPS adding C2 EMC option based on the standard configuration is a category C2 product. In a residential environment, this product may cause radio interference, in which case the user may be required to take additional measures.



 **Conformity and standards**

This product complies with CE 2006/95/EC (low voltage safety) and 2004/108/EC (EMC), EMC standards of Australia and New Zealand (C-Tick), and the following UPS product standards:

- * IEC62040-1 General safety requirements for UPS
- * IEC62040-2-EMC
- * IEC62040-3 Performance requirements and test methods

For details, refer to *Chapter 11 Specifications*.

Continued compliance requires installation in accordance with these instructions and the use of manufacturer approved accessories only.

  **Warning**

The selection of the upstream distribution protection equipment of the UPS shall be selected in accordance with the details in *3.1.4 Selection Of UPS I/O Switch* and shall comply with the local

electrical regulations.

  **Warning: high earth leakage current**

Earth connection is critical before connecting the input supply (including both mains supply and battery).

This equipment is installed with an EMC filter.



Earth leakage current is less than 3000mA.

Transient and steady state earth leakage currents, which may occur when the equipment is started, should be taken into account in the selection of instantaneous RCCBs or RCD devices.

RCCB which is sensitive to unidirectional DC pulse (class A) and insensitive to transient state current pulse must be selected.

Note also that the earth leakage currents of the load will be carried by the RCCBs or RCDs.



The equipment must be earthed in accordance with the local electrical code of practice.

  **Warning: backfeeding protection**

This UPS is fitted with a dry contact closure signal for use with an external automatic disconnect device (supplied by others) to protect against backfeeding voltage into the incoming terminal through the rectifier or bypass static switch circuit. A label must be added at all external incoming primary supply disconnect device to warn service personnel that the circuit is connected to a UPS. The text of the label has the following meaning: Risk of voltage backfeed! Isolate the UPS, then check for hazardous voltage between all terminals including the protective earth before working on this circuit.

  **User serviceable components (For service personnel)**

All equipment maintenance and servicing procedures involving internal access requires the use of a tool and should be carried out only by trained personnel. There are no user-serviceable parts behind covers requiring a tool/key for removal.

  **Battery voltage exceeds 400Vdc (For service personnel)**

All physical battery maintenance and servicing procedures requires the use of a tool/key and should be carried out only by trained personnel.

Take special care when working with the batteries associated with this UPS. When connected together, the battery terminal voltage will exceed 400Vdc and is potentially lethal.

Battery manufacturers supply details of the necessary precautions to be observed in working on, or in the vicinity of, a large bank of battery cells. These precautions should be followed implicitly at all times. Particular attention should be paid to the recommendations concerning local environmental conditions and the provision of protective clothing, first aid and fire-fighting facilities.

  **General safety (For users)**

Like other types of large power equipment, the UPS and battery circuit breaker box/battery cabinet

have high voltage inside. Because the components with high voltage can be accessed only when the front door is opened, the risk of contacting high voltage has been minimized. This equipment meets the IP20 standard, and other safety shields are provided inside the equipment.

There will not be any risk when operating this equipment according to the general instructions and the steps recommended in this manual.



Multiple power inputs (For users)

This UPS system receives power from more than one source. Disconnection of all AC source and the DC source is required before servicing.

This UPS has several circuits that are energized with high AC as well as DC voltages. Check for voltage with both AC and DC voltmeters before working within the UPS.



Warning

When the internal fuse of the UPS is damaged, it must be replaced with fuse of the same electric parameters by qualified personnel.



Important

Beside the communication board is a static sensitive area, an ESD-proof action is critical before contacting with this area.

Revision Information

V1.0 (December 10, 2018)

Initial release.

Contents

| | |
|--|----|
| Chapter 1 Product Information | 11 |
| 1.1 Features | 11 |
| 1.2 Model Configuration | 11 |
| 1.3 Appearance and Components | 12 |
| 1.3.1 Appearance..... | 12 |
| 1.3.2 Components | 12 |
| 1.4 Operating Principle..... | 13 |
| 1.5 UPS State and Operation Modes | 14 |
| 1.5.1 Normal Mode | 14 |
| 1.5.2 Bypass Mode..... | 14 |
| 1.5.3 Battery Mode..... | 14 |
| 1.5.4 ECO Mode (For Single UPS with External Battery Only) | 15 |
| 1.5.5 Fault State | 15 |
| 1.5.6 Maintenance Bypass Mode | 15 |
| 1.6 Specifications | 16 |
| Chapter 2 Installation and Commissioning..... | 18 |
| 2.1 Unpacking and Inspection | 18 |
| 2.2 Equipment's Accessories..... | 19 |
| 2.2.1 UPS | 19 |
| 2.3 Installation Preparation..... | 19 |
| 2.3.1 Location | 19 |
| 2.3.2 Environmental Requirement..... | 19 |
| 2.4 Selecting Power Cables | 21 |
| 2.5 Connecting Battery Cables | 22 |
| 2.6 Single UPS Commissioning | 22 |
| 2.6.1 Start-up Interface..... | 22 |
| 2.6.2 Normal Mode Start-Up..... | 22 |
| 2.6.3 Battery Mode Start-Up | 24 |
| Chapter 3 Parallel UPS Installation and Commissioning..... | 25 |
| 3.1 Features | 25 |
| 3.2 Requirements..... | 25 |
| 3.3 Connecting Power Cables..... | 25 |
| 3.3.1 Connecting Power Cables | 26 |
| 3.3.2 Connecting Parallel Cables | 26 |
| 3.3.3 Connecting Battery Cables | 27 |
| 3.4 Commissioning of Parallel Cables | 27 |
| 3.4.1 Check Before Start-Up..... | 27 |
| 3.4.2 Parallel System Parameters Setting | 28 |

| | |
|---|----|
| 3.4.3 Power-On Commissioning for Parallel System | 28 |
| Chapter 4 Operation and Display Panel | 31 |
| 4.1 Introduction | 31 |
| 4.1.1 LED Indicator | 32 |
| 4.1.2 Audible Alarm (Buzzer)..... | 32 |
| 4.1.3 LCD and Functional Keys | 32 |
| 4.2 Initial Start-Up Guidance | 33 |
| 4.3 LCD Menu Structure..... | 37 |
| 4.4 LCD Screen Types | 37 |
| 4.4.1 Start Screen | 37 |
| 4.4.2 Flow Screen..... | 37 |
| 4.4.3 Main Menu Screen | 38 |
| 4.4.4 Submenu Screen..... | 38 |
| 4.4.5 Default Screen..... | 43 |
| 4.5 Prompt Window | 43 |
| 4.6 UPS Alarm Message List | 44 |
| Chapter 5 UPS Operation Instructions..... | 51 |
| 5.1 UPS Start-Up..... | 51 |
| 5.2 Transfer Procedures Between Operating Modes | 51 |
| 5.3 Transfer from Normal Mode to Battery Mode | 51 |
| 5.4 Transfer from Inverter Mode to Bypass Mode | 51 |
| 5.4.1 Transfer from Bypass Mode to Inverter Mode | 53 |
| 5.4.2 Transfer from Inverter Mode to Maintenance Bypass | 54 |
| 5.4.3 Transfer from Maintenance Bypass to Inverter Mode | 55 |
| 5.5 REPO | 55 |
| 5.6 Auto Restart | 56 |
| 5.7 Language Selection | 56 |
| 5.8 Changing Current Date and Time..... | 58 |
| 5.9 Setting Password | 59 |
| Chapter 6 Communication..... | 63 |
| 6.1 Installing Intelligent Card..... | 63 |
| 6.1.1 Intelligent Card Port..... | 63 |
| 6.1.2 Intelligent Card Option..... | 64 |
| 6.2 Connection Cables for Dry Contact Port | 65 |
| 6.3 Connecting USB..... | 67 |
| 6.4 Connecting Serial Port Communication Cables | 67 |
| 6.5 Connecting Control Port..... | 67 |
| 6.6 Connecting Built-In Ethernet Port..... | 67 |
| Chapter 7 Maintenance..... | 69 |
| 7.1 Fan Maintenance | 69 |

| | |
|---|----|
| 7.2 Battery Maintenance..... | 69 |
| 7.3 Cleaning UPS..... | 70 |
| 7.4 Checking UPS Status..... | 70 |
| 7.5 Checking UPS Function | 71 |
| Chapter 8 Options..... | 72 |
| 8.1 Option List | 72 |
| 8.2 Communication Cables | 72 |
| Appendix 1 LCD Parameter Settings..... | 73 |
| Appendix 2 Glossary | 76 |
| Appendix 3 Hazardous Substances or Elements Announcement..... | 77 |

Chapter 1 Product Information

Power Bank 600 6kVA UPS is an intelligent online UPS system with sine wave output developed by Vertiv Co. The UPS offers reliable and high-quality AC power to the precision instrument.

This chapter introduces the features, model configurations, appearance and components, operating principle, UPS state and operation mode, and specifications of the UPS.

1.1 Features

The UPS features include:

- Output power factor is 1, which enhances the UPS load capacity.
- On-line double conversion efficiency up to 89% and ECO efficiency up to 94%, which provide more efficient products for the customer.
- Product volume decreased by 30% compared with the previous generation; little space occupied, simple handling and assembly.
- Capable of parallel connection to achieve up to 3 + 1 parallel redundant power
- High-frequency double conversion topology structure, with high input power factor, wide input voltage range, and output immune to grid interference, thus adaptable to areas with unstable mains supply
- Full digital control platform and hardware design platform, which can adapt worse unstable mains supply and load impact
- Support 12, 16, 20-block batteries (6kVA). The long back-up model has a built-in large power charger with 13A charging capacity to provide fast charging
- Provide programmable terminals with cascade protection, to protect the key devices for the customer when the load is heavy
- Innovative design of the layout and the whole process greatly promote the reliability of the product; pass high temperature humidity durability experiment test of 1000 hours
- Operation and display panel with colorful LCD to help you learn about the UPS operation state and operating parameters. The LCD display will change according to the layout of the model
- Integrate Ethernet port, support HTTP protocol, and use the web browser to achieve the remote monitoring, no extra monitoring software required
- Full configuration can achieve the functions such as Interlock, external temperature & humidity sensor, and battery module automatic identification
- Capable of ECO power supply mode, which help you save energy to the maximum extent

1.2 Model Configuration

Table 1-1 Model Configurations

| Model | Input | Output | Remark |
|-------|--------------|--------------|--------|
| 6kVA | Single Phase | Single phase | - |

1.3 Appearance and Components

1.3.1 Appearance

The UPS appearance is shown in Figure 1-1.

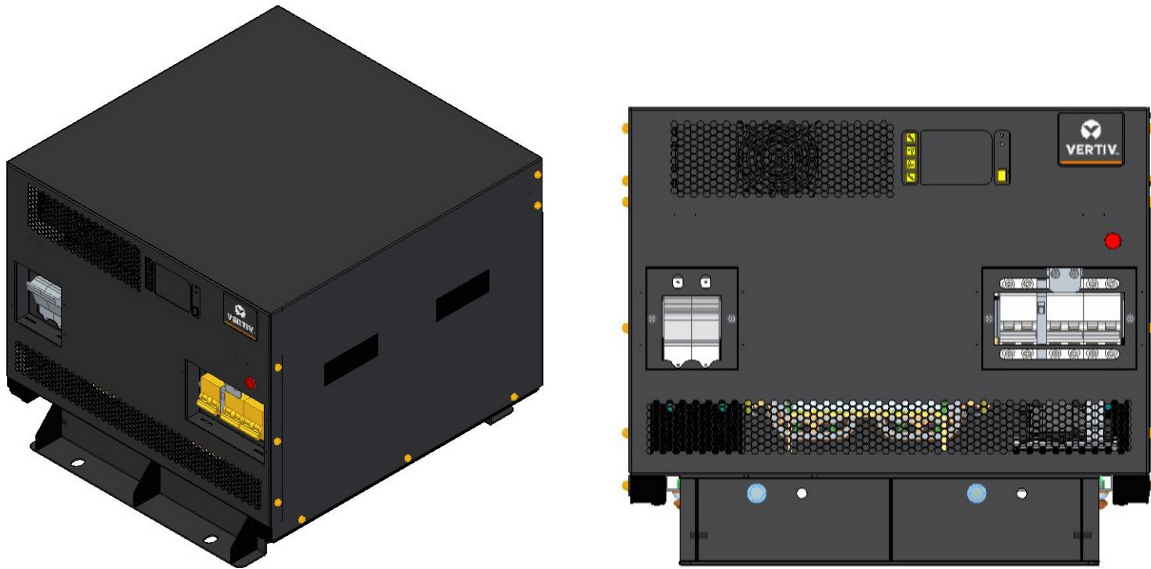

Figure 1-1 UPS Appearance in front and isometric view respectively

1.3.2 Components

Front Panel

As shown in Figure 1-2, the UPS front panel provides operation and display panel, LED indicators and functional keys, MCB and battery fuses.

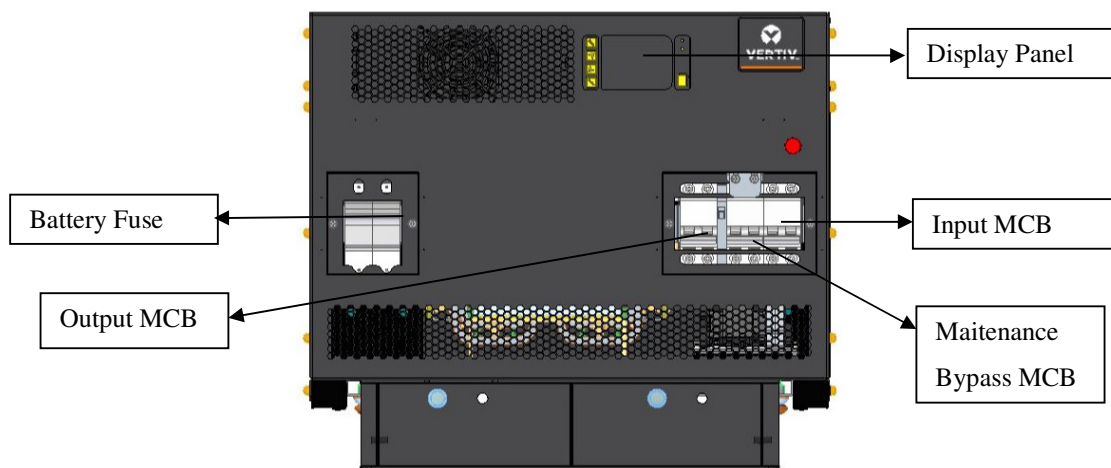

Figure 1-2 UPS front Panel

Rear Panel

As shown in Figure 1-3, the UPS rear panel provides ventilation holes for the module and customer input cable terminations.

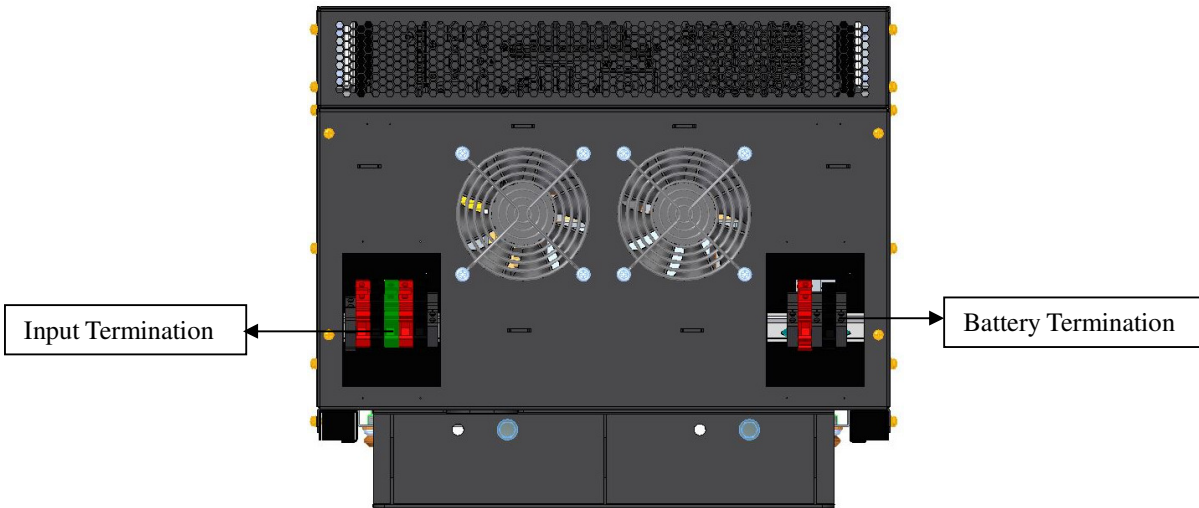

Figure 1-3 UPS Rear side

1.4 Operating Principle

The operating principle of the UPS is shown in the figure 1-4.

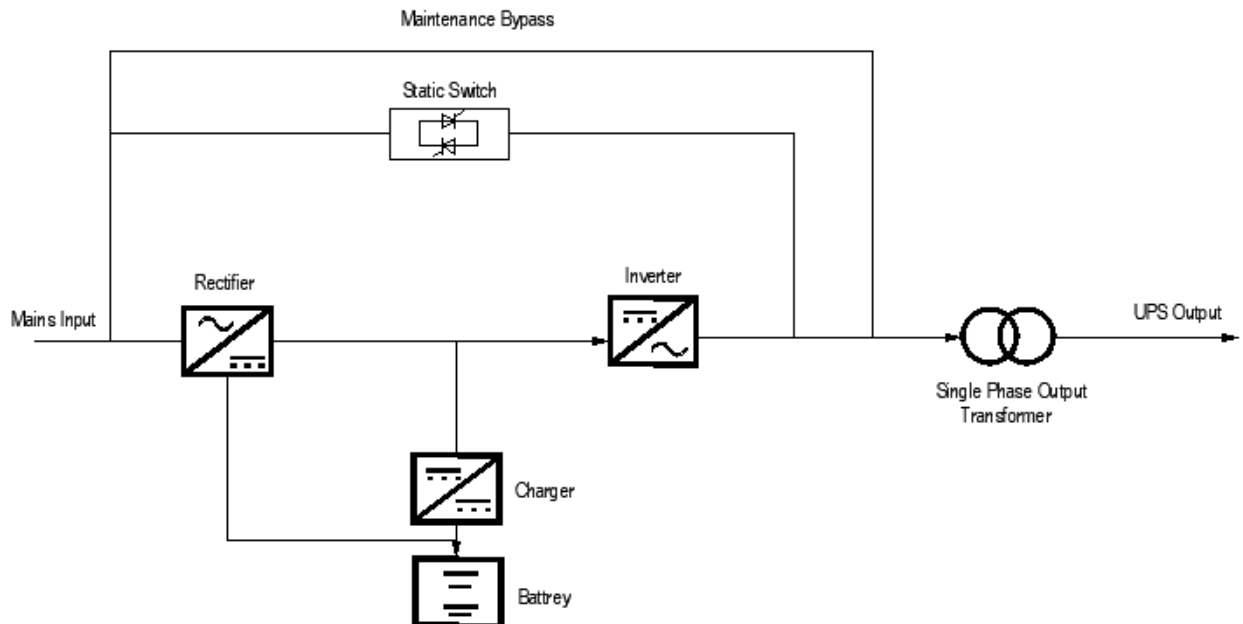

Figure 1-4 UPS Operating Principle

1. The UPS is composed of mains input (main and bypass), rectifier/PFC, charger, inverter, bypass, battery, DSP controller, single phase transformer, contactor and final output.

2. When the mains is normal, the rectifier will start, and the charger will charge the battery string. Before turning on the UPS, the output voltage is bypass voltage, and the mains supplies power to the load through the bypass. After turning on the UPS, the electronic transfer switch connects the inverter output to the load, and the mains supplies DC power to the inverter through the rectifier/PFC circuit. The inverter then converts DC power into pure sine wave AC power and supplies the AC power to the transformer connected to contactor. Final output is supplied to load from transformer secondary through electronic transfer switch. Refer figure 1-3 for the position of contactor and transformer.

3. When the mains is abnormal, the rectifier/PFC circuit boosts the battery voltage and supplies it to the inverter. The inverter then converts it into pure sine wave AC power and supplies the AC power to the load through the electronic transfer switch.

4. After the mains returns to normal state, the UPS will automatically transfer from Battery mode to Normal mode, the mains supply DC power to the inverter through the rectifier/PFC circuit, and then the electronic transfer switch supplies AC power to the load.

1.5 UPS State and Operation Modes

The UPS state and operation mode include: Normal mode, Bypass mode, Battery Mode, ECO mode, Fault State mode and Maintenance Bypass mode. The operation schematic diagrams of Normal mode, Bypass mode, Battery Mode and Maintenance bypass mode are shown in Figure

1.5.1 Normal Mode

When the mains input is normal, the load is supplied with voltage-stabilizing and frequency-stabilizing power by the mains after processing of the rectifier and the inverter, and meanwhile, the charger is charging the battery. The operation mode is Normal mode.

In Normal mode, the run indicator (green) is on, the alarm indicator is off, and the buzzer is silent.

1.5.2 Bypass Mode

If the overload overtime, inverter or rectifier failure appears during the UPS operation in Normal mode, the UPS will transfer to Bypass mode, that is, the load is powered by the bypass source, which comes directly from the mains input. If the rectifier is normal, the internal charger will charge the battery.

In Bypass mode, the run indicator (green) is on, alarm indicator (yellow) is on, and the buzzer beeps every second. The 'Current' page in LCD will display 'On Bypass'.

1.5.3 Battery Mode

Upon mains failure or voltage out of range, the rectifier and internal charger will stop running, and the battery will supply power to the load through the inverter. In Battery mode, the run indicator (green) is on, alarm indicator (yellow) is on, and the buzzer beeps every second. The 'Current' page in LCD will display 'On Battery'.



Note

- 1. The battery has been fully charged before delivery. However, transportation and storage will inevitably cause some capacity loss. Therefore, it is required to charge the battery for eight hours before putting the UPS into operation for the first time, to ensure the adequate backup time for battery.*
- 2. The battery cold start can also be used to start the UPS from the Battery (charged) mode upon mains failure. Therefore, the battery power can be used independently for improving the system availability to some extent.*

1.5.4 ECO Mode (For Single UPS with External Battery Only)

In ECO Mode, the load is powered by bypass when the bypass voltage is normal, and the load is powered by inverter when the bypass voltage is abnormal. ECO mode is an energy-saving operation mode. For power equipment insensitive to power grid quality, you can use the ECO mode for power supply through bypass to reduce the power loss.



Note

- 1. In ECO mode, if the bypass failure or abnormal bypass voltage appears when the output is not overloaded, the UPS will transfer to Normal mode. However, if the bypass failure or abnormal bypass voltage appears when the output is overloaded, the UPS will not transfer to Normal mode, but shut down the bypass.*
- 2. In ECO mode, the efficiency of the UPS is up to 94%.*

1.5.5 Fault State

In the normal mode, the UPS will transfer the load to Bypass mode in case of inverter failure or UPS over-temperature. In Battery mode (with no bypass mains), the UPS will shut down and stop the output if the inverter failure or UPS overtemperature appears. In UPS Fault State, the alarm indicator (red) will be solid on, the buzzer will keep beeping, and the corresponding fault information will be displayed on LCD.

1.5.6 Maintenance Bypass Mode

If maintenance and repair for UPS are needed, you can switch the load to the Maintenance Bypass through maintenance bypass MCB, and the power to the load is not interrupted. The maintenance bypass MCB is located at the Front side of the UPS cabinet, and the capacity meets the requirements of total load capacities.



Note

When the UPS has malfunctions, and can not working normally, please get in touch with the nearest Vertiv branch office or local service center. It is prohibited to repair the UPS by yourself, otherwise the personnel injury and damage to the equipment will occur.

1.6 Specifications

Table 1-2 Specifications

| Item | | Specifications |
|-------------------|---|---|
| | | 6kVA (1-in 1-out) |
| Input | Rated voltage | 220Vac/230Vac/240vac |
| | Volatge Range | 100Vac ~ 288Vac; linear derating from100Vac ~ 176Vac |
| | Rated Frequency | 50Hz/60Hz |
| | Frequency Range | 40Hz ~ 70Hz |
| | Power factor | ≥0.99, at full load; ≥0.98, at half load |
| | Input Thdi | <5%; Linear load |
| Output | Rated power | 5kW/6kW ambient temp is 0-25 C, no output Power derating, derating 0.8 on 40degree, 0.7 on 50 degree |
| | Voltage | 220Vac/230Vac/240Vac (Single phase output) |
| | Frequency synchronization range | Rated frequency±3Hz. Configurable range: ±0.5Hz ~ ±5Hz |
| | Frequency track rate | 0.5Hz/s. Configurable range: 0.2/0.5/1Hz/s (single UPS), 0.2Hz/s (parallel system) |
| | Rated Power Factor | 1 |
| | Crest Factor | 3:1 |
| | Voltage harmonic distortion | < 1% (linear load); < 8% (non-linear load) |
| | Voltage Regulation | ± 1% |
| | Dynamic response recovery time | 60ms |
| | Inverter Overload Capability the utility mode | At 25°C: 105% ~ 125%, 5min; 125% ~ 150%, 1min; 150%, more than 200ms |
| | Inverter Overload Capability the battery mode | At 25°C :105% ~125%, 60~ 30 s ; >125%, more than 200ms |
| Bypass | Bypass Voltage range | Upper limit: +10%, +15% or +20%; default: +20% |
| | | Lower limit: -10%, -20%, -30% or -40%; default: -40% |
| | Bypass Overload Capability | Bypass overload Alarm Present |
| System Efficiency | ECO Mode | > 94% |
| | Mains efficiency (RL) | > 89% |

| Item | | Specifications |
|---------------------------|-----------------------|--|
| | | 6kVA (1-in 1-out) |
| Battery | Type | Sealed, lead-acid, maintenance-free battery |
| | No's of Batteries | 12, 16, 20; 16 by default |
| | | Full load with 16 and 20 blocks 12V VRLA battery on 25° C 70% Load with 12 blocks VRLA battery on 25° C |
| | Rated Voltage | 144Vdc ~ 240Vdc |
| Battery charging capacity | 5A | |
| Transfer Time | Mains - Battery | 0ms |
| | Inverter- Bypass | Synchronous transfer: ≤0ms |
| | | Asynchronous transfer (default): ≤20ms Or 40ms, 60ms, 80ms, 100ms and 200ms are available |
| UPS Parallel Numbers | | 4(N+1) |
| Noise | | < 65dB |
| Panel display mode | | Colorful LCD |
| Protection Level | | IP20 |
| Ambient Conditions | Operating temperature | 0°C ~ 50°C (0.7 will be derated when above 50°C) |
| | Storage temperature | -40°C ~ +70°C (battery excluded); -25°C ~ +55°C (battery included) |
| | Relative humidity | 5%RH ~ 95%RH, non-condensing |
| | Altitude | ≤3000m; derating when higher than 3000m |

Chapter 2 Installation and Commissioning

This chapter briefly introduces the mechanical installation of the UPS, cable connection and commissioning of the single UPS.

Each site has its peculiarity, so this chapter provides the guidance with general installation procedures and methods for the installation engineer who should conduct the installation according to the actual conditions.



- 1. The UPS should be installed by a qualified engineer according to the information contained in this chapter. If any problem is found, please get in touch with Vertiv local service center immediately.*
- 2. The UPS shall not be powered on without approval of the commissioning engineer.*
- 3. For other equipment which is not introduced in this manual, the detailed information about mechanical installation and electrical installation are delivered with the equipment.*

2.1 Unpacking and Inspection

The UPS adopts the carton box. Open carton box as shown in the figure 2-1. Visually inspect the UPS appearance for transportation damage. If any problem is found, please notify the carrier immediately. Check the accessories and models against the delivery list. If any problem is found, please notify the dealer immediately.

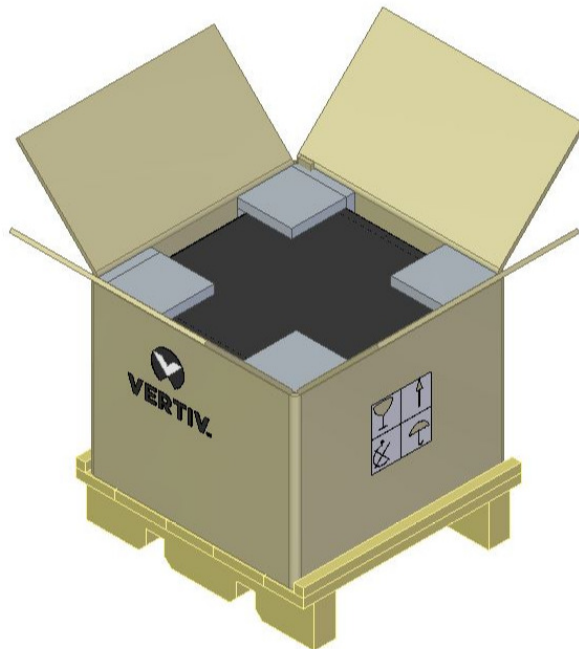

Figure 2-1 Unpacking the UPS

2.2 Equipment's Accessories

This section describes the parts, which are supplied along with the UPS. These parts must be examined on receipt of the system.

2.2.1 UPS

The UPS is mounted on a wooden base palette and fixed on to the same. The unit is wrapped in polythene sheets and enclosed in a corrugated box. The UPS cabinet can be moved by human, or forklift or other similar lifting equipment.

2.3 Installation Preparation

2.3.1 Location

To extend the UPS life, the chosen place must offer:

- Convenient wiring
- Adequate operator access area
- Good ventilation to meet the heat dissipation requirements
- No corrosive gas, such as sulfur dioxide and so on
- No excessive moisture or heat source
- No excessive dust
- Compliance with fire-fighting requirements
- Operating temperature compliant with the specifications, see Table 1-2 for details

2.3.2 Environmental Requirement

UPS room The UPS is designed for indoor installation, which should be installed in a clean and well-ventilated environment, to keep the ambient temperature within the specifications.

The internal fans provide forced air cooling for the UPS. Cooling air enters the UPS through the ventilation holes on the front panel and exhausts the hot air through the back-ventilation holes. Therefore, do not obstruct the ventilation holes. Maintain at least 200mm clearances between the front, rear of the UPS and the wall or adjacent equipment (see Figure 2-2), to avoid obstructing the UPS ventilation and heat dissipation. Otherwise, the UPS internal temperature will rise, which will shorten the UPS life.

If necessary, an indoor exhaust fan should be installed to keep the indoor temperature from rising. An air filter should be used in a dusty environment where the UPS is to be operated.

Space Reserved

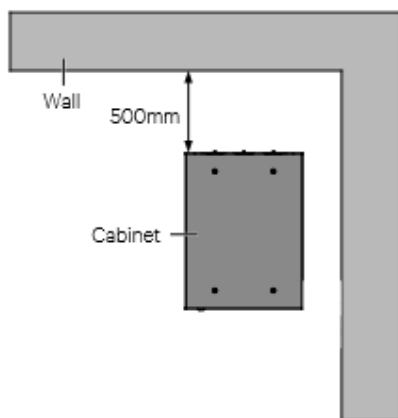

Figure 2-2 Installation Clearances (Top view of rack installation)



Note

1. The UPS should be installed only on the concrete surface or other non-flammable surfaces.
2. As shown in Figure 2-5, the demonstration of the clearance between the rear panel of the cabinet and the wall is 500mm. The clearance should not be less than 200mm, it needs to be considered according to the actual situation for the sake of maintenance convenience.

Battery Room

A small amount of hydrogen and oxygen will be generated at the end of battery charging; therefore, you must ensure that the fresh air ventilation of battery installation environment meets the EN50272-2001 requirements.

The battery ambient temperature should keep constant, for the ambient temperature is the main factor to affect the battery capacity and life. The battery standard operating temperature is 20°C, operation above this temperature will shorten the battery life, and operation below this temperature will reduce the battery capacity. If the battery average temperature in operation rises from 20°C to 30°C, the battery life will be reduced by 50%; if the battery temperature in operation exceeds 40°C, the battery life will be decreased exponentially. In general, the allowed ambient temperature of the battery is 15°C ~ 25°C. The battery should be kept away from heat and ventilation holes.

When the UPS uses an external battery, you must install a battery protective device (such as fuse or circuit breaker) in areas near the battery and use the shortest wiring distance for the connection between the protective device and the battery.

Storage Environment

When the UPS does not need to be installed immediately, the UPS must be stored indoors to be protected from the excessive moisture or over-temperature environment. The battery requires dry and low temperature, well-ventilated environment for storage, and the most suitable storage temperature is 20°C ~ 25°C.

| |
|---|
| Battery Hazards |
| <p><i>During the battery storage, the battery must be periodically charged according to the battery instructions. When charging the battery, you can connect the UPS to the mains temporarily to charge and activate the battery.</i></p> |

2.4 Selecting Power Cables

I/O cables and battery cables are required for connection. When connecting the cables, you should follow the local wiring regulations, take the environment situation into account, and refer to Table 3B of IEC60950-1.

The max. current in different operating modes is listed in Table 2-1, the recommended min. cable CSA is listed in Table 2-2. Select the appropriate cables according to Table 2-1 and Table 2-2.

Table 2-1 Max steady state AC and DC current

| UPS Power(kVA) | Rated Current | | | | | | |
|----------------|-------------------------|------|------|--------------------------|------|------|-------------------------------------|
| | Max Input Phase Current | | | Max Output Phase Current | | | Max.battery discharging current (A) |
| | 220V | 230V | 240V | 220V | 230V | 240V | |
| 6(1-in 1-out) | 36 | 35 | 34 | 28 | 27 | 25 | 35 |



Note

When the battery cables are selected, the maximum allowable voltage drop is 4Vdc according to the current value shown in this table. Do not ring the cables to avoid increasing the electromagnetic interference (EMI).

1: The input mains current of the rectifier and the bypass.

2: Non-linear load (switch mode power) affects the neutral cable design of the output and the bypass. The neutral cable current may exceed the rated phase current, up to 1.732 times as large as the rated current.

Table 2-2 Single UPS cable CSA (unit: mm², ambient temperature: 25 deg C)

| Model | Input | Output | Bypass | Neutral Cable | PE | Battery | Battery PE |
|---------------|-------|--------|--------|---------------|----|---------|------------|
| 6(1-in 1-out) | 6 | 6 | / | 6 | 6 | 6 | 6 |

The recommended I/O MCB capability of the UPS is listed in Table 2-3; select the MCBs according to your requirements.



Note

1. The UPS is high leakage current equipment, it is not recommended to use the MCB with leakage current protection.

2. The specified upstream breakers below are required to obtain the conditional short-circuit current rating, Icc at 10kA symmetrical rms. The specified upstream breakers should comply with an IEC 60947 series Standard.

Table 2-3 UPS I/O MCB Selection

| MODEL | Recommended capability of input external MCB | Battery Fuse/MCB Selection | Recommended capability of output external MCB | Recommended capability of Maintenance bypass external MCB |
|---------------|--|----------------------------|---|---|
| 6(3-in 1-out) | 40A (mains) 40A (bypass) | 50A | 40A | 40A |

2.5 Connecting Battery Cables

1. Before connecting the battery cables, confirm that the actual battery cell number and capacity are consistent with the parameter settings on the LCD menus.
2. It is prohibited to reverse the polarity of the battery cables.
3. Before replacing the battery module and connecting the battery cables, disconnect the DC battery MCB, power off the UPS completely, and conduct isolation protection on the terminals.
4. It is recommended that the battery cable should not be longer than three meters. Otherwise, the UPS cannot operate normally.

2.6 Single UPS Commissioning

2.6.1 Start-up Interface

If the system is first start-up, only mains input mode can be used, and the LCD screen will display the start-up interface, see figure 2-3.

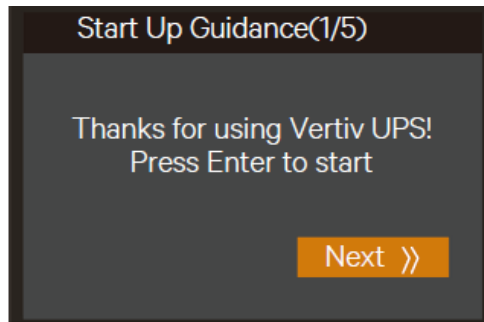



Figure 2-3 Start up interface

2.6.2 Normal Mode Start-Up

1. Close the external output MCB and input MCB of the UPS one by one.
 2. The rectifier runs in normal state for about 30 seconds, the start-up of the rectifier is finished.
 3. Finish and check the parameter settings of the single UPS.
- a) At main menu screen, press the  or  key to select 'Settings', and press the key to enter the interface shown in Figure 2-4.

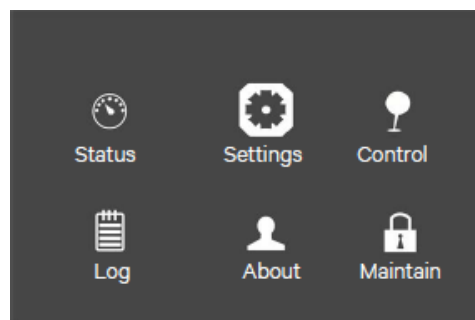



Figure 2-4 Main menu screen

b) Press the  or  key to select and set corresponding parameters (taking 'Output' as an example). As shown in Figure 2-5.

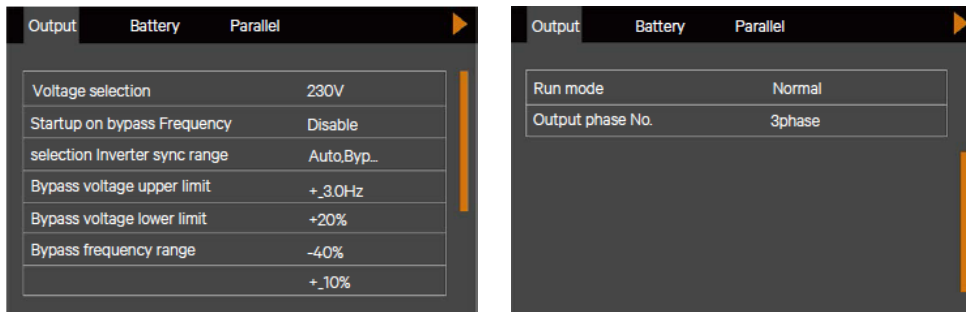

Figure 2-5 Output interface screen

4. After setting corresponding parameters, press the power button for two seconds, and the LCD prompts a dialogue box shown in Figure 2-6.

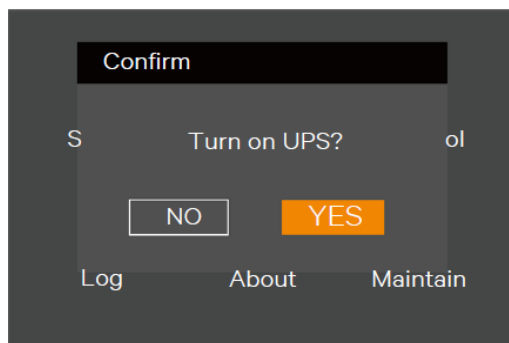

Figure 2-6 Turning on UPS

After selecting 'YES', the run indicator (green) blinks, the inverter starts, and the run indicator turns on.

5. Measure whether the inverter output voltage is normal.

6. If the battery is not connected, the alarm indicator is yellow. If the battery is connected, the alarm indicator turns off.

2.6.3 Battery Mode Start-Up

1. Close the battery MCB and press the power button on the UPS front panel for two seconds, the LCD displays the startup screen. The alarm indicator will be yellow, and the buzzer will beep continuously after the rectifier finishes the startup.
2. Press the power button for two seconds, the LCD prompts a dialogue box shown in Figure 2-7.

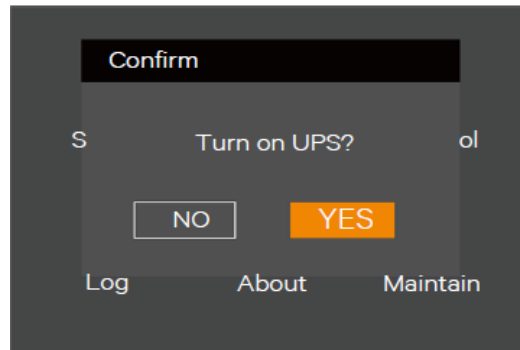

Figure 2-7 Turning on UPS

After selecting 'YES', the inverter starts, and the run indicator (green) is on.

Chapter 3 Parallel UPS Installation and Commissioning

This chapter introduces the features, requirements, installation and commissioning of the parallel system.

The UPS parallel system provides the user with $N + X$ ($2 \leq N + X \leq 4$, $X=0$ or 1) parallel configuration, N stands for the basic parallel sets, X stands for the redundant sets.

3.1 Features

1. The software and the hardware of each UPS in parallel system are the same as those of the single UPS. The basic parameters of the parallel system can be set through the LCD (Refer to 3.5.2 Parallel System Parameters Setting for details), and the detailed parameters can be set through the background software (For service engineers only).
2. The parallel cables form a ring connection (Refer to 3.4.2 Connecting Parallel Cables for details) to provide reliability and redundancy for the system. The intelligent parallel logic provides the user with maximum flexibility. For example, each UPS in the parallel system can be switched off or on in random order; seamless transfer can be achieved between Normal mode and Bypass mode, and the transfer is automatically recoverable: that is, after the overload is removed, the system will return to the original operation mode automatically.
3. The total load of the parallel system can be queried through the LCD of each UPS.

3.2 Requirements

A UPS system composed of multiple parallel-connected UPSs is equivalent to a large UPS system. Nevertheless, it provides increased system reliability. To ensure equal utilization of all UPSs and compliance with relevant wiring regulations, the following requirements must be met:

1. All single UPSs must have the same capacity.
2. If a residual current detector (RCD) is required, it must be set correctly and installed before the same neutral line input terminal, or it must monitor the protective earth current of the system. Refer to 'Warning: high leakage current' of Safety Precautions before Contents.
3. The outputs of all single UPSs must be connected to the same output bus.
4. Because the UPS parallel system is not fitted with any auxiliary contact detection devices for the output MCB of the UPS, removing the single UPS from the parallel system before maintenance and adding the single UPS into the parallel system after maintenance must be conducted strictly following the procedures provided in 5.2 Transfer Procedures Between Operation Modes. Failure to observe this may affect the reliability of the load power supply.

3.3 Connecting Power Cables

Each single UPS of the parallel system needs to configure the MCB and cables respectively, refer to 2.4 Connecting Power Cables for the specification. The recommended configurations of the total power cables are listed in Table 3-1 and Table 3-2 for the parallel system.

3.3.1 Connecting Power Cables

The power cables of the UPS are connected to the I/O terminal block of the rear panel of the UPS, the layout of the I/O terminal block is shown in 2.6.1 Connecting I/O Cables.

Table 3-1 Input & Output cable CSA for 6 kVA parallel system (unit:mm², ambient temperature: 25 deg C)

| Parallel UPS number | 1-in 1-out | | |
|---------------------|--|--|---|
| | Total input Phase line for parallel system | Total output cable for parallel system | Total grounding cable for parallel system |
| 2 Units | 16 | 16 | 16 |
| 3 Units | 35 | 35 | 35 |
| 4 Units | 50 | 50 | 50 |

3.3.2 Connecting Parallel Cables

The parallel system provides parallel cable option. The parallel cables form a ring connection through the parallel ports on the rear panel of the UPS. The cable connection schematic diagram of 1 + 1 parallel system is shown in Figure 3-1.

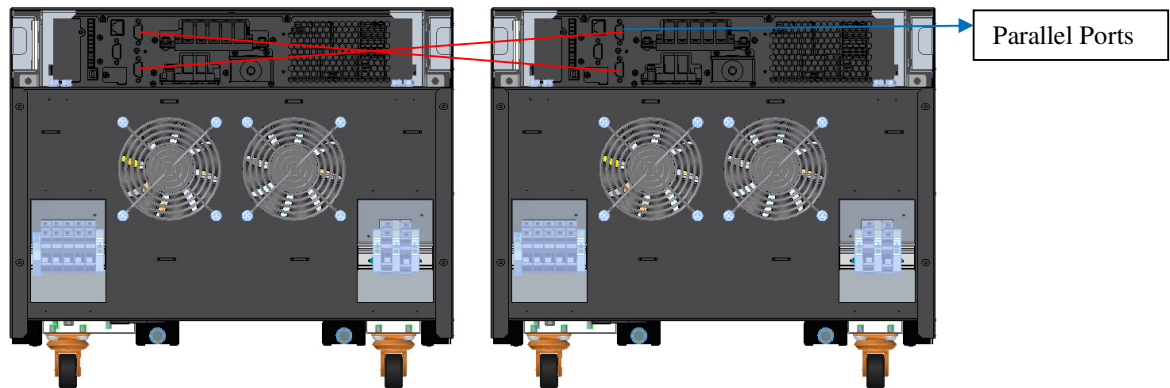

Figure 3-1 Cable Connection schematic diagram of 1 + 1 parallel system



Note

1. The Vertiv parallel cables must be used for the parallel system.
2. If the parallel communication fault occurs during the parallel commissioning or operation just shut off the system and check whether the connection of the parallel cables is correct.
3. During parallel system operation, do not unplug the parallel cables to avoid system damage risk.

3.3.3 Connecting Battery Cables

In the parallel system, the 6kVA UPS can only use the battery strings independently.

Using battery string independently

When each UPS of the parallel system uses the battery string independently, the battery cables connection of each UPS in the parallel system is the same with that of the single UPS, refer to 2.5 Connecting Battery Cables for the installation method. The schematic diagram of battery strings in 1 + 1 parallel system with independent battery strings is shown in Figure 3-2 (a) and (b). Refer to 2.4 Connecting Power Cables to configure an MCB.



Note

Make sure that the LCD settings are correct when using the battery strings independently for the parallel system, refer to 3.5.2 Parallel System Parameters Settings for details.

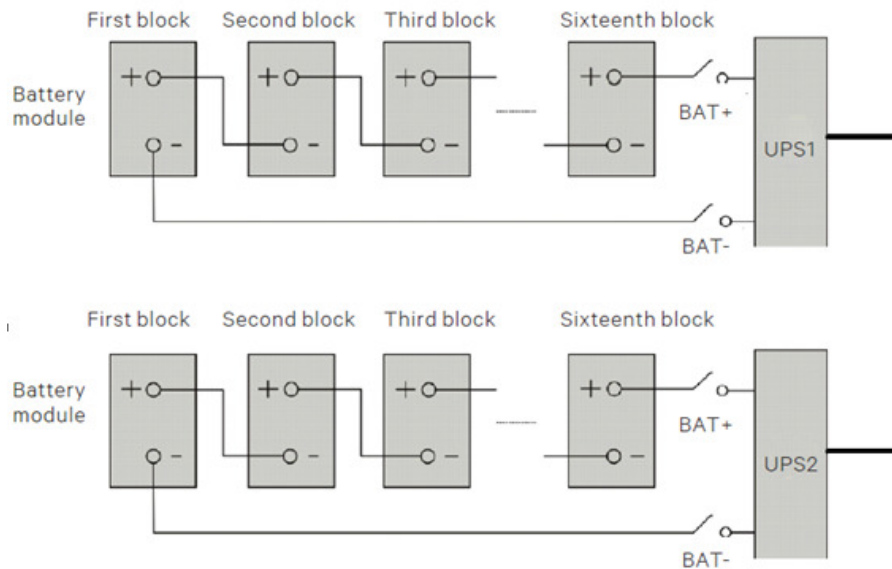

Figure 3-2 Connection Principle Diagram upon using battery string independently in 6kVA

3.4 Commissioning of Parallel Cables

3.4.1 Check Before Start-Up

1. Check and confirm that power distribution mode of the is correct; that connections of the power cables and the signal cables are correct and there is no short circuit.
2. Check that the battery installation and cable connection is correct and there is no short circuit, and that the positive pole and negative pole of the battery are correct.
3. Check all the working status of the parallel system, ensure that the phase sequence of the main, bypass and output of each UPS is correct and consistent, that the connection of the parallel cable is reliable, and that the user load is not

connected during power-on.

4. Measure and confirm that the mains voltage and frequency are normal.

5. The output terminals of the UPS is energized upon the start-up. If the load is connected with the output terminals, make sure that the power to the load is safe.



The output terminals of the UPS will be live upon start-up. When bypass of the single UPS in the parallel system is not consistent, the system fault may occur, check and confirm the bypass before power-on.

3.4.2 Parallel System Parameters Setting

The parallel parameters for all the UPSs in the parallel system should be set. As shown in Figure 3-3.

| Output | Battery | Parallel |
|--------------------------|---------|--------------|
| Voltage selection | | 230V |
| Frequency selection | | Auto,Bypa... |
| Run mode | | Normal |
| Redundant | | YES |
| System parallel num | | 1 |
| Output phase No. | | 3phase |
| Sync parallel parameters | | |

Figure 3-3 Setting for parallel parameters

The user can change these settings according to actual needs, for instance two units are connected in parallel then in the settings System parallel num will be 2; refer to Appendix 1 LCD Parameters Setting for details. After the change, press the last item 'Sync parallel parameters' to validate the setting.

3.4.3 Power-On Commissioning for Parallel System

1. Set the parallel parameters of each UPS in the parallel system, then commission the inverter. The specific commissioning procedures are as follows:

a) Make sure that the output MCBs of all UPSs in the parallel system are open, and then close the external input MCB of each UPS in the parallel system, the UPS is powered on at the same time.

b) The LCD displays the self check screen, and the alarm indicator (red) and run indicator (green) are on at the same time for about five seconds.

c) After the rectifier has been in normal operation state for about 30 seconds, the rectifier start-up is finished.

- d) Refer to 3.5.2 Parallel System Parameters Setting for the parallel parameters setting for each UPS. Note whether there is an alarm of 'Parallel comm. Fail', if yes, clear the fault according to Table 4-5. Carry out the following procedures if the UPS is running normally.
- e) Press the power button of one UPS for 2 seconds, then press the Enter key to start the UPS. The run indicator (green) will blink, after 20 seconds, the inverter will start, and the run indicator will turn on.
- f) If the battery is not connected, the alarm indicator will be solid on, and the buzzer will beep every second. If the battery is connected, the alarm indicator will turn off.
- g) If the UPS is working normally, press the power button for two seconds to turn off the inverter.
- h) Repeat the preceding step a) ~ step g) to power on and commission the inverter of other UPSs respectively.



Note

1. Carry out the parallel commissioning after each UPS is working normally.
 2. After confirming that the inverter of each UPS is normal, commission the parallel system, the specific procedures are as follows:
 - a) Close the external output MCB and input MCB of each UPS, and all UPSs are powered on at the same time. After the start of the rectifier is finished, press the power button of one UPS for two seconds, the run indicator (green) will be on. Measure whether the inverter output voltage is normal.
 - b) Start the inverter of the second UPS, check whether there is an alarm on the LCD, and confirm that the UPS parallel works normally.
 - c) Follow the methods to start the inverter of the third or the fourth UPS to connect the UPS into the parallel system.
3. If the user needs to add one UPS in the parallel system, follow the commissioning procedures below:
 - a) Check and confirm that the power distribution mode, each power cable and signal cable of the added UPS are well connected without short circuit. Check that the battery installation and cables connection are correct without short circuit, and that the positive and negative are correct.
 - b) Repeat steps a) to h) in Part 1 to complete the single unit commissioning of the added UPS. Then completely power off the UPS.
 - c) Ensure that the connection of power cable and signal cable is reliable.
 - d) For any online UPS, enter the interface shown in Figure 3-7. Set the system parallel No. from 'N' to 'N+1', then click

the 'Sync parallel parameters'.

e) Close the external I/O switches of the added UPS, normally start the inverter after the rectifier start-up. Then check that the LCD has no alarm, and that the UPS parallel system works normally.



Note

- 1. For 1+1 parallel system, when one UPS is faulty and needs to be replaced on line, the above operation steps are available too. The difference is no need to change parallel No., just click the 'Sync parallel parameters' for the online UPS.*
- 2. Clicking the 'Sync parallel parameters' to achieve the synchronization of the items in parallel settings interface, and the parameters will affect the parallel system. The user should manually set other parameters according to actual needs.*
- 3. When adding a single unit in the parallel system, first ensure the parallel cables connection is correct, then power on the single unit.*

Chapter 4 Operation and Display Panel

This chapter introduces the function and use of the components of the UPS operation and display panel, and provides LCD display options information, including LCD screen types, detailed menu messages, prompt windows message and UPS alarm list.

4.1 Introduction

The operation and display panel is located on the front panel of the UPS. Through the operation and display panel, you can conduct the operation and control on the UPS and query all the UPS parameters, UPS and battery states, and alarm message.

As shown in Figure 4-1, the operation and display panel provide LCD, menu keys, LED indicators (run indicator and alarm indicator).



Figure 4-1 LCD Screen

**Note**

1. The device has a gravity sensor function; thus, the LCD display direction will be changed according to the device layout mode.

4.1.1 LED Indicator

The LED indicators are composed of run indicator and alarm indicator. Table 4-1 gives the indicator description.

Table 4-1 Definition of Indicators

| Indicator | Colour | State | Description |
|-----------------|--------|----------|---|
| Run indicator | Green | On | UPS has Output |
| | | Blinking | Inverter is Starting |
| | | Off | UPS has no output, Inverter is starting |
| Alarm indicator | Yellow | On | Alarm Occurs |
| | Red | On | Fault Occurs |
| | / | Off | No Alarm, No Fault |

4.1.2 Audible Alarm (Buzzer)

UPS activity is accompanied by the two kinds of sound listed in Table 4-2.



Table 4-2 Description of audible alarm



| Alarm sound | Meaning |
|---------------------------|---|
| One beep every 0.5 second | Sound is generated when the UPS critical alarm appears, such as Inverter overload |
| One beep every second | Sound is generated when the UPS critical alarm appears, such as battery low voltage |
| One beep every 3.3 second | Sound is generated when the UPS general alarm appears |
| Continuous beep | Sound is generated when the UPS fault appears, such as fuse or hardware failure. |

4.1.3 LCD and Functional Keys

The operator control and display panel provide five control keys, as described in Table 4-3.

Table 4-3 Description of Control Keys

| Control key | Silkscreen | Description |
|-------------|---|---|
| Confirm |  | Used to confirm or enter |
| Up |  | Used to page up, turn left or add value, etc. |
| Down |  | Used to page down, turn right or reduce value, etc. |

| | | |
|--------|---|---|
| Escape |  | Used to back, escape, cancel or forbid operation Power |
| Power |  | Used to power on, power off or transfer to Byapss mode |



Note

It is required to hold and press the preceding keys for 2s to initiate the key function.

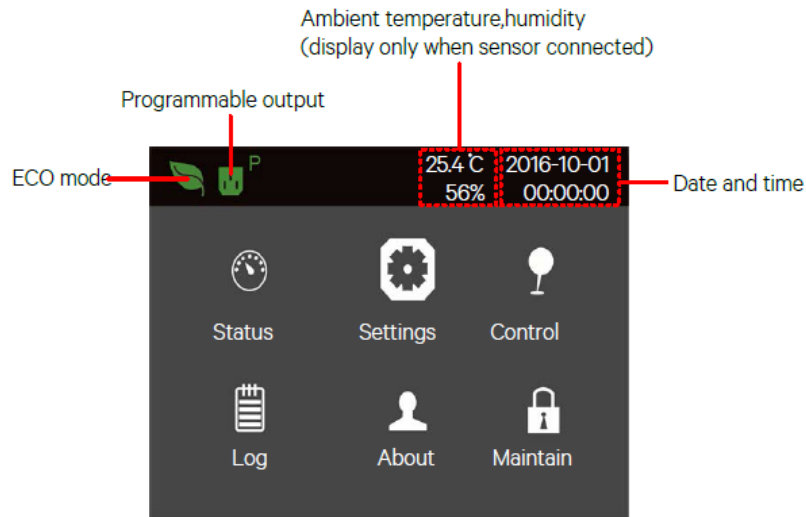

Figure 4-2 LCD Screen

LCD provides you with the user-friendly interface and the 320 × 240 dot matrix image display. The user-friendly and menu-driven LCD allows you to easily browse through the UPS input, output, parameters of the load and the battery, learn about the current UPS status and alarm message, perform functional settings and control operation. The LCD also stores historical alarm records that can be retrieved for reference and diagnosis.

4.2 Initial Start-Up Guidance

When the UPS is the initial start-up, the interface shown in Figure 4-3 will appear to guide the user to set basic parameters of the UPS.

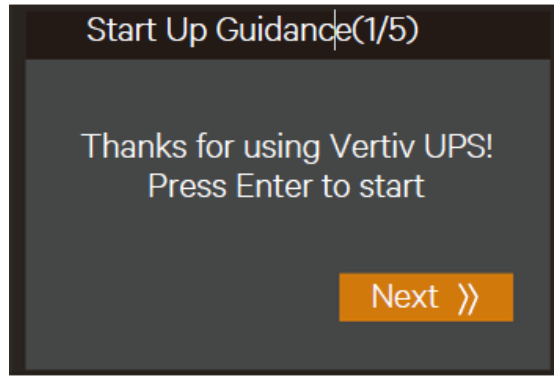

Figure 4-3 Initial start-up guidance (1)

Initial start-up guidance (1)

Welcome page

Click Next to start the guidance.

Language, date and time page

At this page, you can set the language, date and time you need.

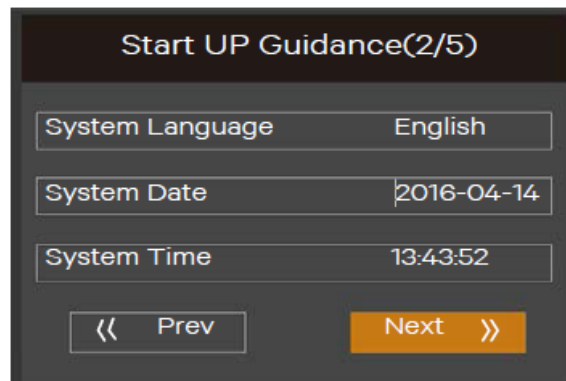

Figure 4-4 Initial start-up guidance (2)

Battery parameter page

At this page, you can set the battery cell number and total Ah.

For 6kVA model, the 'Battery series' are 12, 16, and 20 selectable. See Figure 4-5.

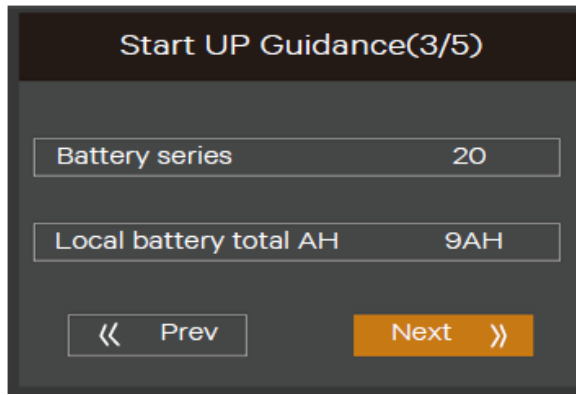

Figure 4-5 Initial start-up guidance (3)

If there is an external battery module, the 'Local battery total Ah' will not appear, see Figure 4-6.

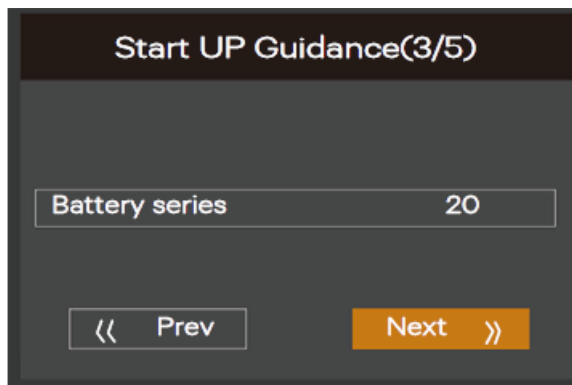

Figure 4-6 Initial start-up guidance (3)

Output page

As shown in Figure 4-8, you can set output voltage, output frequency, and output phase.

For 6kVA model, the 'Output phase No.' cannot be set because the model only has single phase output. See the diagram in Figure 4-7.

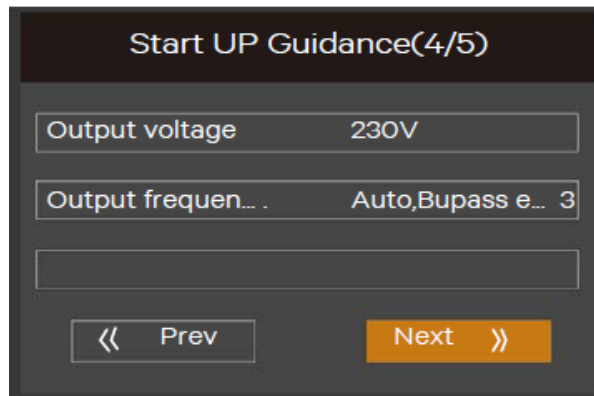

Figure 4-7 Initial start-up guidance (4)



Note

For output page, all the settings must unplug the REPO terminal (forcible output shutdown), otherwise the interface shown in Figure 4-8 will appear

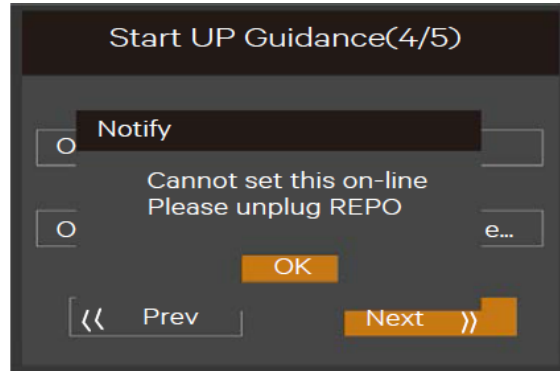

Figure 4-8 Prompt of removing REPO terminal

Finish page

For 6kVA model, the interface shown in Figure 4-9 will appear. Click Finish to enter the Flow page, then the user can operate the UPS normally.

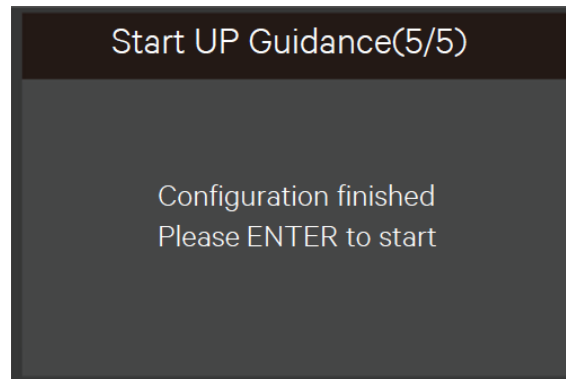

Figure 4-9 Initial start-up guidance (5)

After the start-up, the user can operate the UPS normally,

4.3 LCD Menu Structure

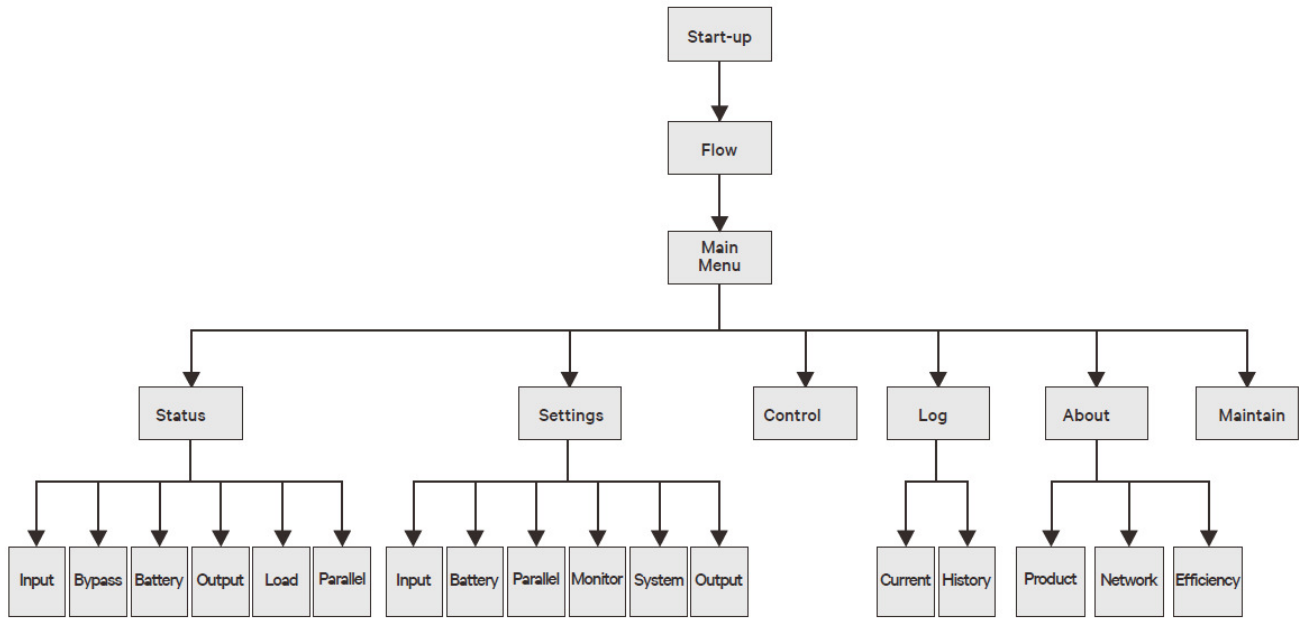

Figure 4-10 LCD Menu Structure

4.4 LCD Screen Types

4.4.1 Start Screen

Upon UPS start-up, the UPS executes the system self-test, and the start screen will appear and remain for about 10 seconds, as shown in Figure 4-11.



Figure 4-11 Start Screen

4.4.2 Flow Screen

After the self-test of the UPS, the flow screen shown in Figure 4-12 will appear.

The flow screen is the total status view of the UPS, includes input, bypass, rectifier, battery, inverter and output, etc. The working modes with color display while the invalid modes with gray display.

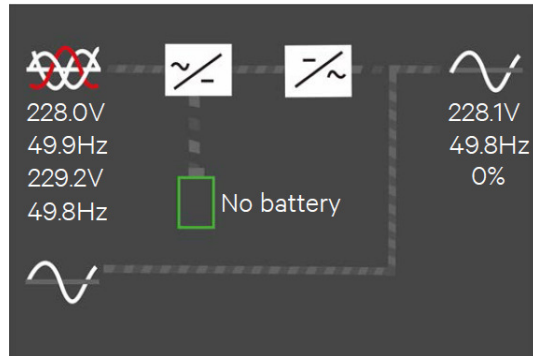

Figure 4-12 Flow Screen

4.4.3 Main Menu Screen

The main menu screen is composed of six icons: Status, Settings, Control, Log, About, Maintain. As shown in Figure 4-13.

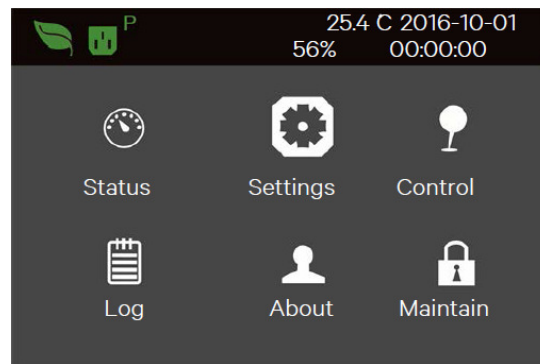









Figure 4-13 Main Menu Screen

At main menu screen, press the  key to back to the flow screen. Press the  or  key to switch the cursor to select the submenu you need, then press the  key to confirm it.

4.4.4 Submenu Screen

The submenu screen contains the UPS parameters and item settings. After entering the submenu screen, if there is a tab control, just move the cursor to the tab. Now, you can press the  or  key to switch the tab. Press the  key to move the cursor to a certain item.

After entering the submenu screen, if there is no tab control, then the cursor will stop at a certain Item.

Press the  key to back to the previous screen.

For details about the submenu screen, see following pages.

Status page

The Status page contains the Input, Bypass, Battery, Output and Load. See below

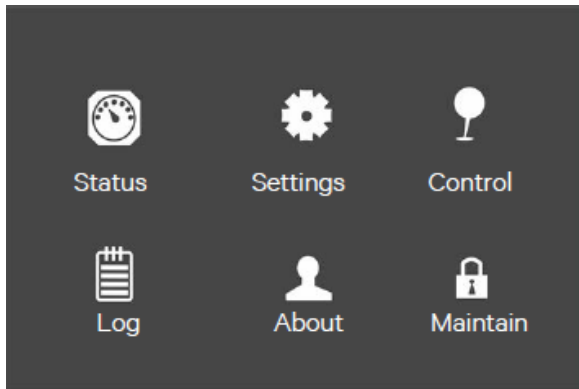

| Input | Bypass | Battery | Output |
|----------------|--------|---------|--------|
| L-N voltage(V) | 230 | 230 | 230 |
| L-N current(A) | 0.59 | 0.31 | 0.96 |
| Frequency(Hz) | 48.98 | 48.98 | 48.98 |
| L-L voltage(V) | 380 | 380 | 380 |
| Power factor | 0.27 | 0.00 | 0.22 |
| Energy(kWh) | 2.768 | | |

| Input | Bypass | Battery | Output |
|----------------|--------|---------|--------|
| L-N voltage(V) | 230 | | |
| Frequency(Hz) | 48.98 | | |

| Input | Bypass | Battery | Output |
|-------------------------|---------|---------|--------|
| Battery status | Battery | NoBatt | NoBatt |
| voltage(V) Battery | 0.00 | 0.00 | |
| current(A) Backup | 0.00 | 0.00 | |
| time(Minut... Remaining | 0.0 | | |
| capacit... External | 0 | | |
| battery c... | 0 | | |

| Input | Bypass | Battery | Output |
|----------------|--------|---------|--------|
| L-N voltage(V) | 230 | | |
| L-N current(A) | 0.00 | | |
| Frequency(Hz) | 0.00 | | |

| Load | |
|-----------------|------|
| Sout(kVA) | 0.00 |
| Pout(kW) | 0.00 |
| Power factor | 0.00 |
| Load percent(%) | 0 |

Settings page

The Settings page contains the Output, Battery, Parallel, Monitor, System, and Outlet. For details about the parameters setting, refer to Appendix 1 LCD Parameters Setting. See below:

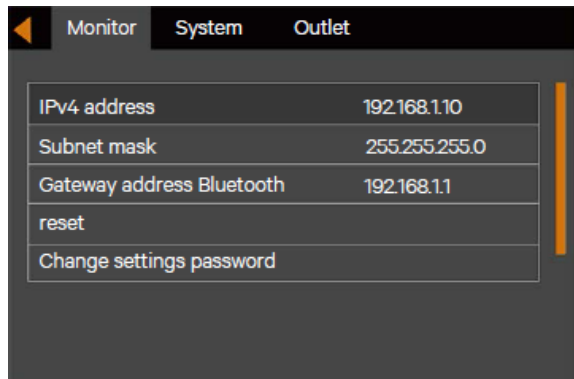
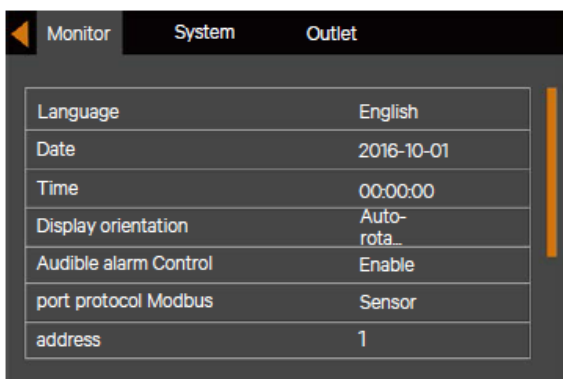
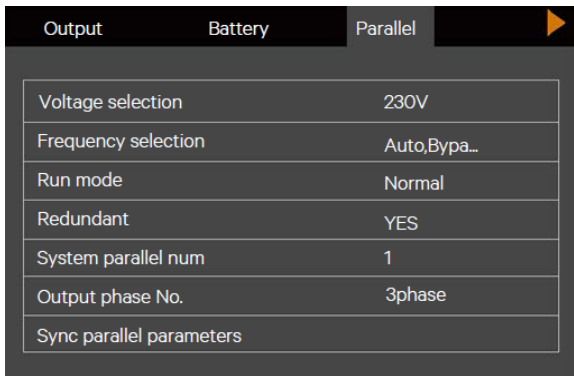
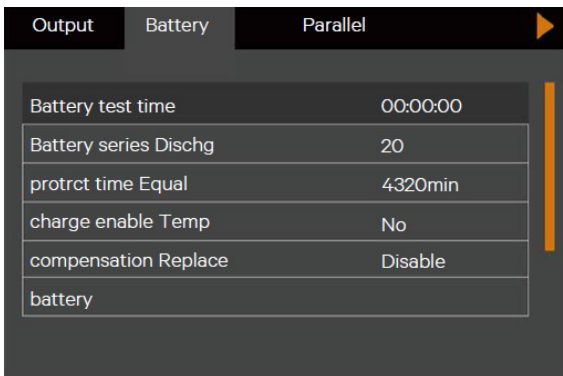
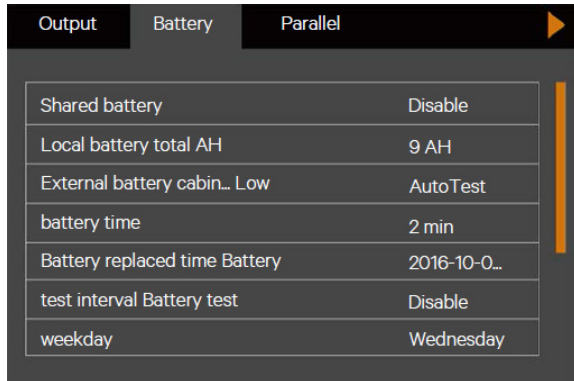
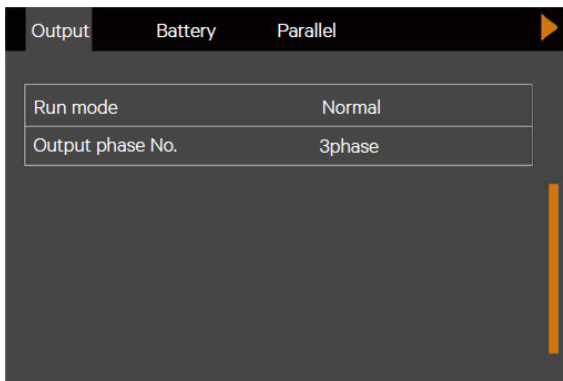
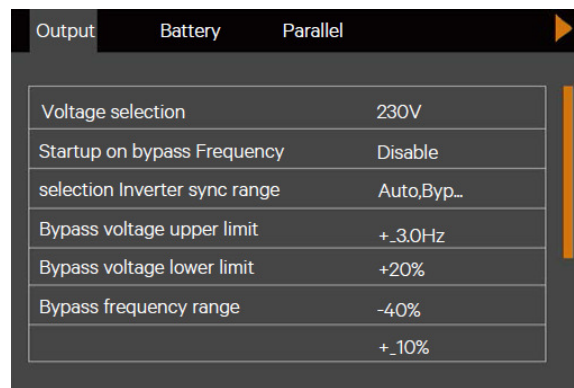
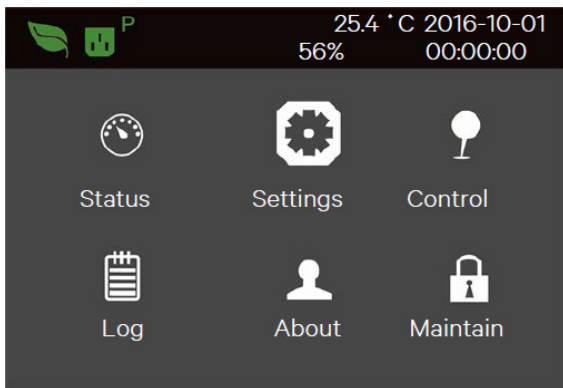

| Monitor | | System | Outlet |
|-----------------------|---------|--------|--------|
| Auto restart | Enable | | |
| Auto restart delay | 10 sec | | |
| Guaranteed shutdown | Disable | | |
| Remote control Remote | Enable | | |
| power on delay Remote | 0 sec | | |
| shutdown delay | 0 sec | | |
| Redundant | YES | | |

| Monitor | | System | Outlet |
|-----------------------------|-------------|--------|--------|
| LBS select | Disable | | |
| IT system compatibility Dry | Disable | | |
| connect 1 (Output) Dry | Low battery | | |
| connect 2 (Output) Dry | UPS fault | | |
| connect 3 (Input) Dry | Maintain... | | |
| connect 4 (Input) | Maintain... | | |

| Monitor | | System | Outlet |
|---|------|--------|--------|
| Turn off | | | |
| Reboot | | | |
| Turn off when UPS over... | No | | |
| <input type="checkbox"/> Turn off when UPS on... | 2min | | |
| <input checked="" type="checkbox"/> Turn off when backup... | 0min | | |
| <input checked="" type="checkbox"/> Turn off when batter... | 30% | | |
| <input checked="" type="checkbox"/> Turn on when powerr... | 0min | | |

Control Page

The Control page contains the Turn ON/OFF/to BYPASS, and Manual battery test, etc.

See below:

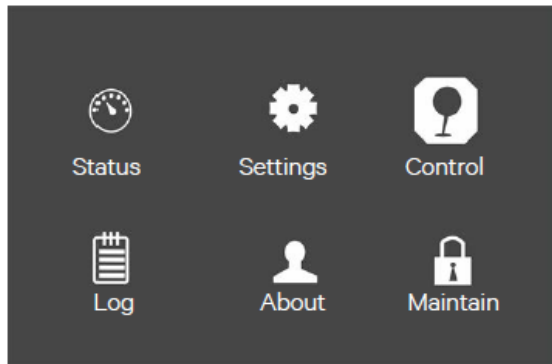

| | |
|---|---------------------|
| Turn ON/OFF/to BYPASS | |
| Mute/Unmute audible alarm Start/ | |
| Stop manual battery test Clear | |
| faults | |
| <input type="checkbox"/> Power on time | 2016-10-01 00:00:00 |
| <input type="checkbox"/> power off time | 2016-10-01 00:00:00 |

Log page

The Log page contains the Current and History. See below:

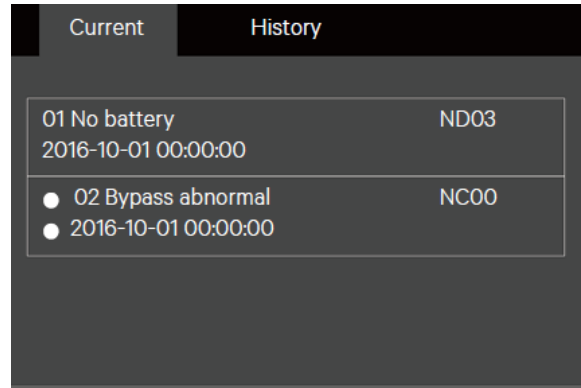
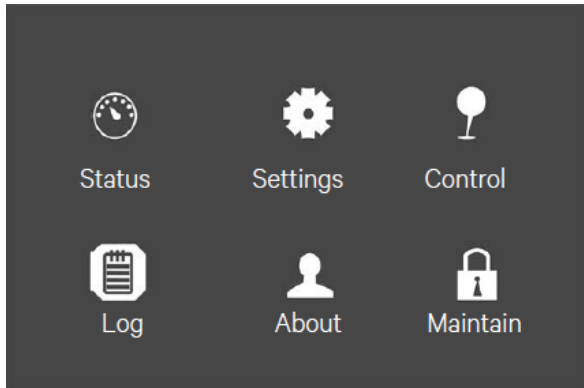

About page

The About page contains the Product, Network, and Efficiency. See below:

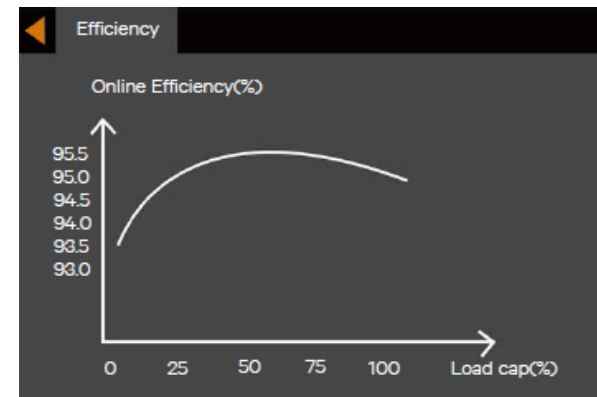
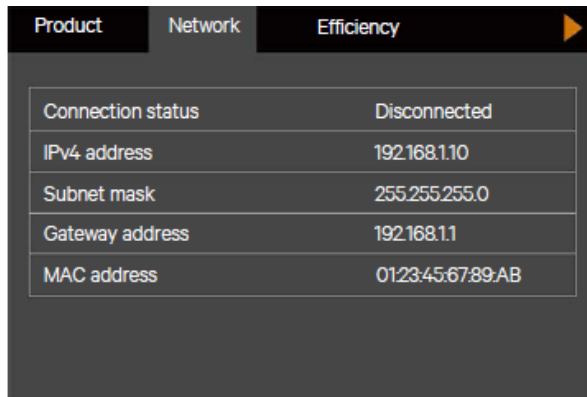
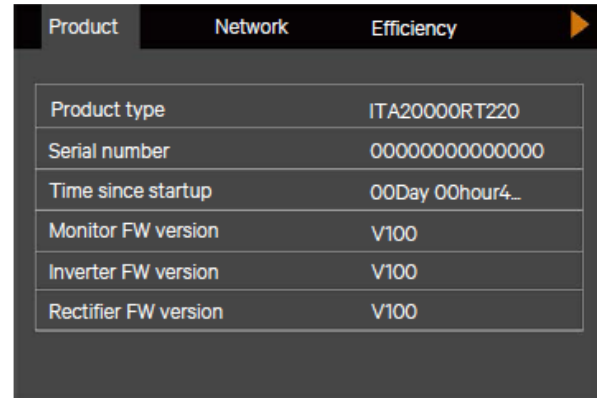
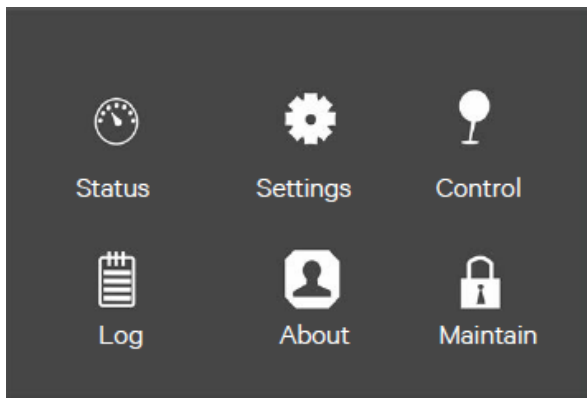

Maintain page



Note

The Maintain page needs correct password and for Vertiv service engineer operation only.

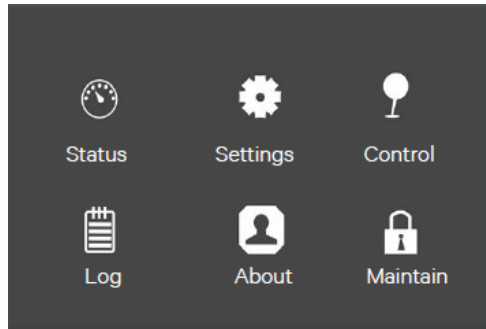

4.4.5 Default Screen

During the UPS operation, if there is no alarm within two minutes, the default screen shown in Figure 4-14 will appear. At the default screen, if there is an alarm or a fault, or the user press any key, the Flow screen will appear again.

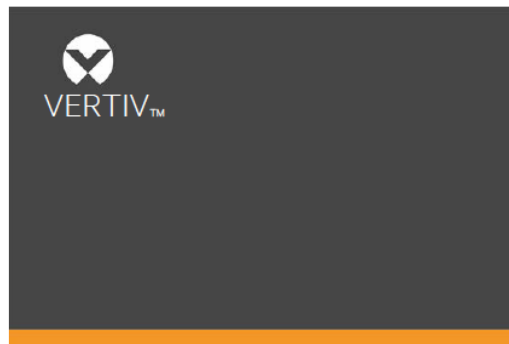

Figure 4-14 Default Screen

4.5 Prompt Window

A prompt window is displayed during the operation of the system to alert you to certain conditions and/or to require your confirmation of a command or other operation. Table 4-4 lists the prompts and meanings.

Table 4-4 Prompts and meaning

| Prompt | Meaning |
|---|--|
| System setting is different, please check | When the parallel parameters are different, the prompt will appear |
| Cannot set this online, please shut down output | If the user wants to change some important settings under condition of output (output voltage, output frequency, output phase No.), the prompt will appear |
| Incorrect password, please input again | The prompt will appear when the user incorrectly input the Settings password |
| Operation failed, condition is not met | The prompt will appear when the user wants to execute a certain operation but the condition is not met |

| Prompt | Meaning |
|--|---|
| Password changed OK | The prompt will appear when the user successfully changes the Settings password |
| Fail to change password, please try again | The prompt will appear when the user tries to change the Settings password but input two different new passwords |
| The time cannot be earlier than system time | The prompt will appear when the user set the time of 'Turn on delay' or 'Turn off delay' is earlier than the current system time |
| Turn on failed, condition is not met | When users press the power button (or execute the command of 'Turn on/Turn off/to Bypass' under 'Control' page), the prompt will appear |
| Cannot set this on line, please unplug REPO | If the user wants to change output phase No. under condition of output, the prompt will appear |
| Please disconnect power, check output: 1 phase, 3 phase, then power UPS on | The prompt will appear when the output phase is changed. The system requires the user to power off and check the cables connection, then power on the UPS again to guarantee the safety |

4.6 UPS Alarm Message List

Table 4-5 gives all UPS alarm messages based on the 'Current' and 'History' menus.

Table 4-5 Alarms and meaning

| Alarm | Explanation |
|---------------------------------|--|
| Communication fail | Internal communication is abnormal, please check the communication cables are connected correctly or not |
| Rectifier fault | The rectifier is faulty and off |
| DC/DC fault | The discharger is faulty, because the bus voltage exceeds the setting range when discharger starts or soft starts |
| DC bus abnormal | The inverter is off when DC bus voltage is faulty. The load will transfer to bypass if the bypass is available |
| Charger fault | The charger output voltage is abnormal, and the charger is off |
| Aux. power fault | The auxiliary power output voltage exceeds the normal range |
| Input backfeed Battery mode. | The mains relay short circuit, and the difference between mains and battery voltage is less than the setting range |
| Inverter fault | The inverter is off when the inverter output voltage and current exceed the setting range. If bypass is available, the UPS will transfer to bypass mode, otherwise the system will power off |
| Output short | Check that the output cables are not shorted |
| Bypass backfeed | The bypass relay is shorted, or the SCR is damaged |

| Alarm | Explanation |
|--|--|
| battery mode. | |
| Output off, voltage is not zero | When there is no output, the system detects that the output has a voltage zero |
| Inverter relay welded | The inveter relay is shorted |
| Parallel No. abnormal | The parallel online number is different from the setting number. Please check that the parallel number at 'Settings' page is the same as the actual online number, and that the parallel cables are normal |
| Parallel comm Fault | The local UPS and its online frequency configuration is different or the parallel address is conflicted. Please check that the parallel system paramerte setting is the same as the local parameter setting |
| Parallel cable Connection abnormal | Detect the parallel cables are loosened |
| Input neutral lost | The AC input mains N line is not detected. Please check that the input N line is opened or loosened |
| Input ground lost | Check that the PE line is well connected, and the alarm can be cleared on line |
| Input phase Reversed | The mains AC input phase is reversed. Normally, phase B lags phase A of 120 degrees, and phase C lags phase B of 120 degrees. Check that the UPS mains input phase sequence is correct. If not, just modify it |
| Input abnormal | The retifier and charger are off due to the mains voltage and frequency exceeding normal renage. Check that the rectifier input phase voltage and frequency exceed the normal range or that the mains has power-off |
| Rectifier overload | The output power is larger than the rectifier overload point. Check that the input volatge meets the output load, mains input 176V ~ 100V, the load 100% ~ 50% linear derating |
| Battery reversed | The battery positive and negative are reversed. Please reconnect the battery and check the battery cables connection |
| Battery low pre-warning | This alarm occurs when the battery reaches the EOD. After the pre-warning, the battery capacity allows two minutes discharge at full load. The user can set the time ranging from 2min~30min, (2 min by default). Please shut down the load timely |
| Battery voltage Abnormal | When battery is connected, the system checks that the battery voltage exceeds the normal setting ranges. Check that the battery terminal voltage exceeds the normal range |
| No battery | Check the battery and battery cables connection |
| Battery series not Qualified | The actual connected battery cells are different from the setting cells. Please change to the same |

| Alarm | Explanation |
|---|--|
| Battery aged | The battery capacity is less than 25% of the initial capacity. Battery replacement is recommended |
| Battery test fail | The battery low voltage is detected when the battery has manual or peroidal self-test. Battery replacement is recommended |
| Battery overtemp | Battery ambient temperature too high. Check that the battery ambient temperature is higher than setting value 40 ~ 60°C (default: 50°C) |
| Battery cabinet not connected | The battery cabinet is not connected to the system |
| Fan fault | At least one fan is faulty. Check that the fan is blocked, or the cables connection is loosened |
| System overtemp | Internal heat sink temperature too high, and the inverter is off. Only each module heat sink temperature decreased to the setting value can you silence the alarm. The system can automatically start after overtemperature fault is solved. If overtemperature, please check: 1. Ambient temperature too high or not 2. Dust is blocked or not 3. Fan fault or not |
| Inverter overload | Inverter load capacity is larger than the rated value, overload delay time is up, inverter shuts down. If bypass is available, the system will transfer to the bypass mode, otherwise the output is failure. Check that the actual inverter load capacity, if overloaded, just reduce the load capacity, and the system will transfer to the inverter mode after five minutes with alarm cleared |
| Bypass phase Reversed | The bypass voltage phase sequence is reversed. Normally, phase B lags phase A of 120 degrees, and phase C lags phase B of 120 degrees. Check that the UPS bypass input phase sequence is correct. If not, just modify it |
| Bypass Overcurrent | The bypass current exceeds the rated value. Overload delay time is up, inverter shuts down |
| Parallel bypass cable connection abnormal | The bypass phase number is different from the output phase number under 'Monitor'. Please check that the bypass cables connection is the same as the configured phase number |
| Byapss abnormal | Maybe caused by bypass voltage and frequency outside of range, bypass power-off and incorrect bypass cables connection. 1. Check that the bypass voltage and frequency are within the setting range. 2. Check the bypass cables connection |
| Bypass abnormal in ECO mode | The ECO mode is available, and the bypass voltage and frequency are outside of the setting range. Check that the bypass input voltage and frequency are within the setting range |
| Output LPE short | The output and enclosure are shorted. Check whether the output cables connection and the enclosure are shorted or not |

| Alarm | Explanation |
|--------------------------------|---|
| Output pending | Remote shutdown is enabled, and the system will be off |
| Output disabled | The system is in standby state, and the dry contact shutdown is enabled. Check whether the shutdown dry contact is enabled or not |
| Version Incompatible | The version between monitoring board and DSP board is incompatible |
| Electric leak Alarm | Short circuit between bus and enclosure or between battery and enclosure. Check whether the bus and battery cables connection are shorted with the enclosure or not |
| On maintenance bypass | The dry contact in maintenance bypass state is activated |
| Battery mode | The UPS is on battery, and the inverter starts |
| Bypass mode | The UPS is on bypass |
| System overload | The parallel system load capacity is larger than the max. load capacity outputed by parallel sets. Confirm the parallel system load capacity, if overloaded, just reduce it |
| Loss of Redundancy | After the parallel redundancy is enabled, the system load capacity is larger than the rated load of (online set minus one) |
| Load sharing Abnormal | Load sharing is abnormal in parallel system |
| System parallel settings async | Check that parallel setting parameters of each unit are the same |
| Local parallel settings async | Check that the Settings page is the same between this local unit and other units |
| LBS abnormal | Check whether the LBS cables are normal, the system is in stand-by state, or system on bypass and the bypass unable to trace |
| REPO | Shutdown caused by the REPO terminal Normally Closed contact open |
| Bypass phase Reversed | During parallel connection, the bypass phase sequence is not the same. Check the parallel bypass cables connection |
| System battery low pre-warning | In parallel system, all the devices powered by the battery inverter have battery low voltage pre-warning |
| Battery test started | The battery periodical self-test and manual self-test started |
| Battery test Stopped | The battery periodical self-test or manual self-test finished |
| EOD turn off | The inverter is off due to EOD. Check the mains power-off state and recover the mains in time |
| Guaranteed Shutdown | Under forced EOD mode, the battery discharging finished, then system shuts down |

| Alarm | Explanation |
|-------------------------------------|--|
| Shutdown due to Overtemp | During the UPS operation, the system checks that the heat sink temperature exceeds the setting range. If overtemperature, please check: 1. Ambient temperature too high or not 2. Dust is blocked or not 3. Fan fault or not |
| Remote shutdown | Dry contact activated at any mode shutdown |
| Remote power-on | Remotely power on |
| Remote shut-off | Remotely power off |
| Load off due to shutdown on battery | Shutdown in battery mode |
| Output off due to bypass abnormal | The bypass is abnormal, and the bypass is in standby state from working state. Check that the bypass input is normal |
| Battery to utility transition | The UPS is powered by the mains instead of the battery |
| Manual power-on | Set power-on via LCD panel |
| Manual shutdown | Set shutdown via LCD panel |
| Operating inverter on | The UPS output state is on inverter |
| Battery series set to 12 (12~20) | The battery cells changed (6kVA) |
| Restore factory defaults | Under UPS standby state, set 'Restore Factory Defaults' function via the Maintain page |
| Output phase No. set to 1 | The output phase is changed from 3-phase to 1-phase |
| Output phase No. set to 3 | The output phase is changed from 1-phase to 3-phase |
| UPS is out of service | The UPS is out of service |
| Turn on programmable outlet | The programmable outlet status is changed from Turn Off to Turn On |
| Turn off | The programmable outlet status is changed from Turn On to Turn Off |

| Alarm | Explanation |
|--|--|
| programmable outlet | |
| System parallel settings start sync | Manually set the 'Sync parallel parameters' command to activate the event |
| Local settings sync OK | Local parameters are successfully synchronized |
| System settings sync OK | All the parameters are successfully synchronized |
| Load off due to output short | The inverter short circuit or the bypass short circuit. Please check it |
| Output off due to overload & bypass abnormal | The output is off due to output overload and bypass abnormal. Please check it |
| Parallel No. Abnormal | The parallel online number and the configured number are different. Please check that the parallel number under Setting page is the same as the actual online number, and that the parallel cables are normal |
| Bypass disabled | In Settings->Output->Frequency selection, 'Auto, BypDisa; 50Hz, BypDisa; 60Hz, BypDisa' is set, the LCD will generate BypDisa alarm |
| On intelligent sleep mode | After the intelligent sleep mode is enabled, the system has N sets of inverter start-up. When the system meets the sleep requirement (Condition of entering sleep mode: Shared large battery string (If no large battery string, the sleep mode will cause the battery charging failure, host sleep enable, inverter side no fault or alarm, rectifier side no fault or alarm, with battery but large battery no charging need, rectifier not on battery mode, wait for 1h after exiting the former sleep, not master and the local unit ID number except sleep module has no start-up command within 5 minutes). When the N minus 2 units' rated load is larger than the existing system rated load capacity, the unit with the largest ID number starts to enter sleep mode (inverter off), at this time, the N minus 1 units are working in inverter mode. The N minus 3 units are larger than the current system rated load capacity, and the unit with the largest ID number keeps sleep mode |
| Battery cabinet Connect abnormal | The system detects the number of battery cabinet is over six, then reports the battery cabinet connection is abnormal |
| Battery cabinet not connected | The battery cabinet group number is specified, but the communication cables are not connected |
| Battery EOD | Battery end of discharge |
| Faults cleared | Press the 'Clear faults' button under 'Control', then the system will record this event |
| Manual shut off | After the user shuts the UPS output, then the system will record this event |
| System warning | In parallel system, the alarm occurs when UPS's self-adapting output frequency is inconsistent. Solution: Power on again |

| Alarm | Explanation |
|--------------|--|
| System fault | The alarm occurs when model identification is incorrect. Solution: Contact service manager |



Note

If the alarm is caused through setting the software value by Vertiv authorized engineer, and when you wish to change the setting values, please get in touch with the Vertiv local customer service center.

Chapter 5 UPS Operation Instructions

This chapter gives a detailed description of the UPS operation procedures.

During the operation, the buzzer alarm may appear, at this point, you can press the  key for three seconds to silence the audible alarm.



Warning: Hazardous mains and/or battery voltage exists behind the protective cover

1. No user accessible parts are located behind the protective covers that require a tool for removal.
2. Only qualified service personnel are authorized to remove such covers.
3. If maintenance for rack is needed, notice that the neutral line is live.

5.1 UPS Start-Up

The start-up procedures can be performed after the installation is finished, the system has been commissioned by authorized engineer and the external input MCBs are closed.



Important

This procedure results in mains voltage being applied to the UPS output terminals. Confirm that the load power is safe, if there is a load to be connected with the UPS output terminal. Ensure that the load is isolated with the UPS output terminal, if the load is not ready for accepting the power.

The start-up mode of the single UPS includes normal mode start-up and battery mode start-up; refer to 2.6.2 Normal Mode Start-Up and 2.6.3 Battery Mode Start-Up for details.

5.2 Transfer Procedures Between Operating Modes



Note

The Inverter operation mode includes Normal mode (mains inverter) and Battery module (battery inverter).

5.3 Transfer from Normal Mode to Battery Mode

In case of mains failure, the UPS will transfer to Battery mode. If you wish to transfer the UPS from Battery mode to Normal mode, wait few seconds for mains input recovery. Ten seconds later, the rectifier will restart automatically, and the inverter will restore the power.

5.4 Transfer from Inverter Mode to Bypass Mode

In standby mode, press and hold the power button. If the rectifier and inverter are normal, the interface shown in Figure 5-1 will appear, select 'YES' to turn on the UPS.

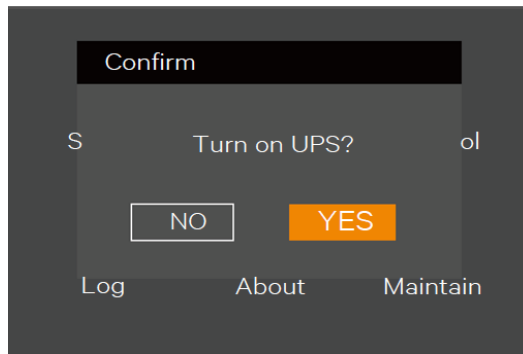

Figure 5-1 Turning on UPS

In Inverter mode, press and hold the power button. If the bypass is normal, the interface shown in Figure 5-2 will appear. Select 'To the Bypass' and click OK to transfer the UPS to Bypass mode; select 'Turn off UPS' and click OK to turn off the UPS.

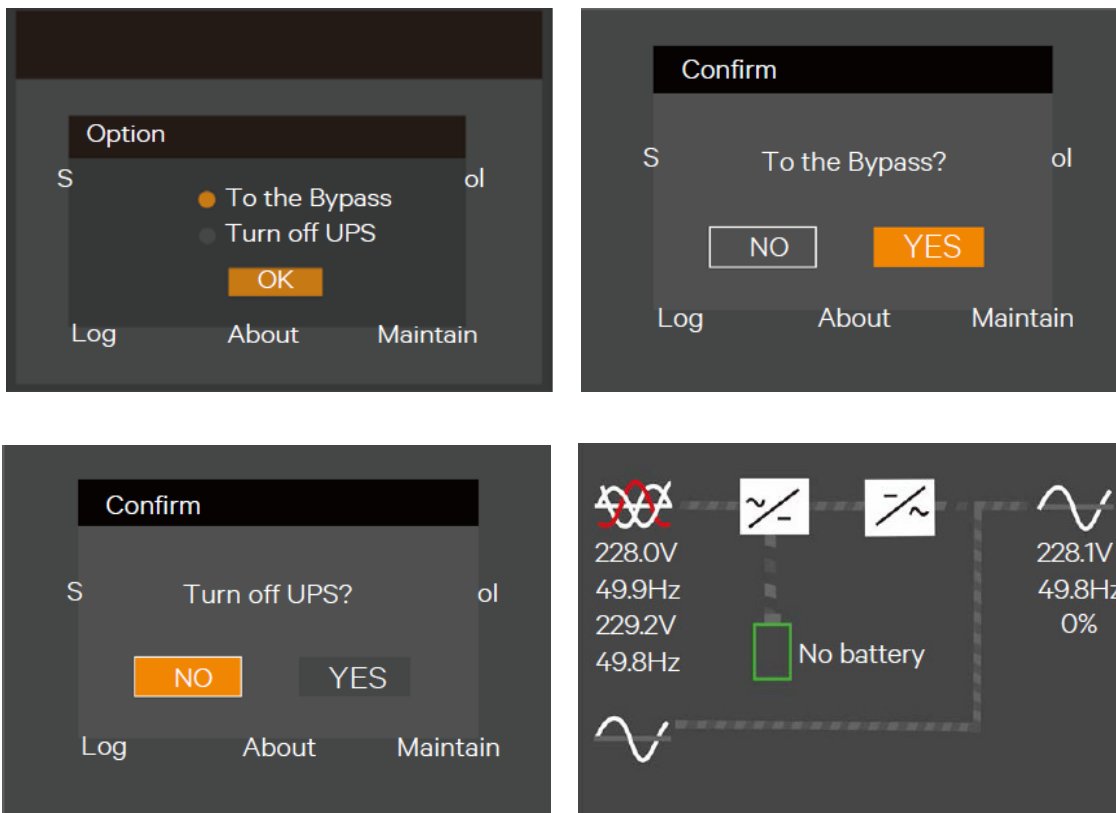

Figure 5-2 Bypass Normal Interface

In Inverter mode, press and hold the power button. If the bypass is abnormal, then the interface shown in Figure 5-3 will appear, select 'YES' to shut down the UPS output.

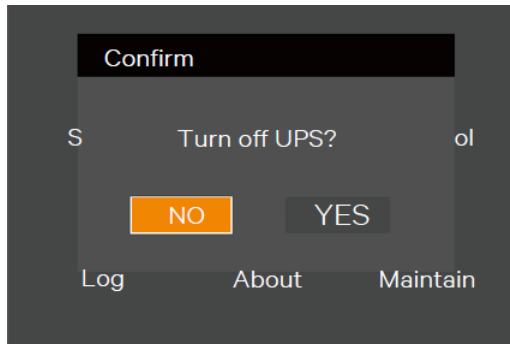

Figure 5-3 Bypass abnormal interface



Note

In Bypass mode, the load accepts the power not from the pure power outputted by the inverter, but from the mains power directly.

For the detailed information of the Normal mode, Bypass mode, Battery and Maintenance Bypass mode, please refer to section 1.5 UPS State and Operation Mode.

5.4.1 Transfer from Bypass Mode to Inverter Mode

In Bypass mode, press and hold the power button.

If the ECO mode is not turned on, the interface shown in Figure 5-4 will appear.



Figure 5-4 ECO Mode not turned on

Select 'Turn on UPS' and click OK to transfer to the Inverter mode, see Figure 5-5.

Select 'Turn off UPS' and click OK to shut down the UPS output.

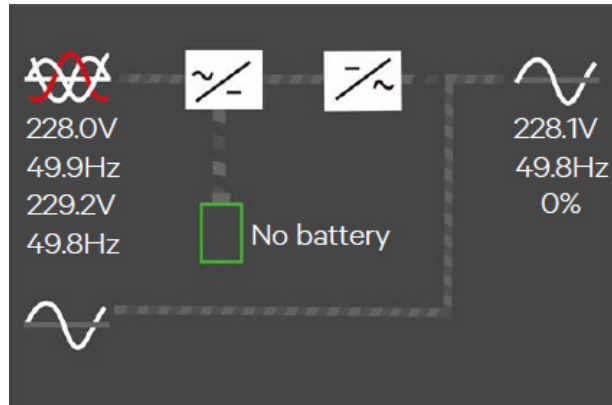

Figure 5-5 Bypass to inverter Mode

If the ECO turned on, the interface shown in Figure 5-6 will appear. Select 'YES' to shut down the UPS output.

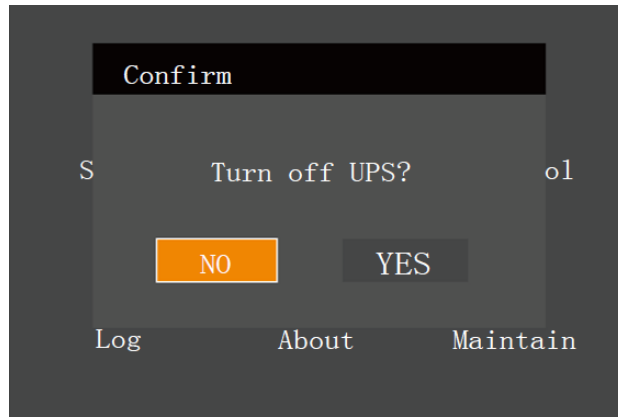



Figure 5-6 ECO turned on interface Mode

5.4.2 Transfer from Inverter Mode to Maintenance Bypass

When the UPS is running in Normal mode, you can use this procedure to make the load transfer from inverter output to maintenance bypass.

| | |
|---|------------------|
|  | Important |
| <p><i>1. Before performing this procedure, you should check the LCD information first, and make sure, the bypass is normal and synchronizes with the inverter. Otherwise, it may result in the load power interruption for a while.</i></p> | |

1. Through the LCD settings page, change the Dry connect 3 to 'Maintain mode'. See Figure 5-7.

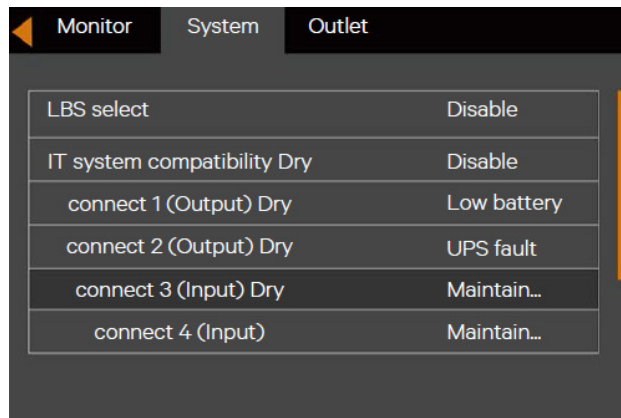



Figure 5-7 Changing dry contact 3 to “Maintain Mode”

2. Connect one end of the maintenance bypass signal cable to Dry Contact Port 3 of the UPS and the other end to the NO/NC Auxiliary contact.
3. Remove the screws securing the Bracket of the maintenance bypass switch.
4. Turn Off Inverter.
5. Confirm that the UPS has transferred to internal bypass mode.
6. After confirmation, close the maintenance bypass switch

Note: Dry contact port 4 can achieve the same function as dry contact port 3 via the steps mentioned above.

5.4.3 Transfer from Maintenance Bypass to Inverter Mode

After UPS maintenance, you can use this procedure to transfer the load from the maintenance bypass to the inverter.

| |
|--|
|  Important |
| <p><i>In Maintenance bypass mode, After UPS maintenance, the UPS must be manually transferred to bypass mode and the output switch must be closed. Failure in doing so may cause equipment damage.</i></p> |

1. Close the mains input MCB and bypass input MCB on the rear panel of the UPS. The UPS will turn on and operate in Bypass mode.
2. Confirm that the UPS is in Bypass mode, then close the output MCB on the rear panel of the UPS.
3. Open the maintenance bypass MCB on the rear panel of the UPS.
4. Fix Bracket of the maintenance bypass switch to its original position, then fasten the fixing screws.
5. Press the power button, and the UPS transfers to Inverter mode.

5.5 REPO

Located at rear of the UPS, the REPO port is designed to switch off the UPS in emergency conditions (such as fire, flood). The system will turn off the rectifier, inverter and stop powering the load immediately (inverter and bypass output included), and the battery stops charging or discharging. Just unplug the terminal connecting to the REPO if you need emergency power-off.

If the mains input is present, the UPS control circuit will remain active; however, the output is closed. To remove all mains power from the UPS, the external main input MCB should be disconnected.

5.6 Auto Restart

When the mains power failure, the UPS draws power from the battery to supply the load until the batteries are depleted, then the UPS will shut down.



The UPS will automatically restart and recover output power supply:

- After the mains power is restored.
- The UPS Auto Restart function is enabled.
- After the Auto Restart is delayed (default: 10s). During the Auto Restart delay, the UPS will charge the battery to provide a safety margin for equipment shutdown if input power fails again.

If the Auto Restart function is disabled, you can restart the UPS manually by pressing the power button.

5.7 Language Selection

The LCD menus are available in two languages: Chinese, English. Procedures for selecting the language:

1. At the main menu screen, press the  or  key to switch the cursor to select 'Settings', then press the  key to confirm it. See Figure 5-8.

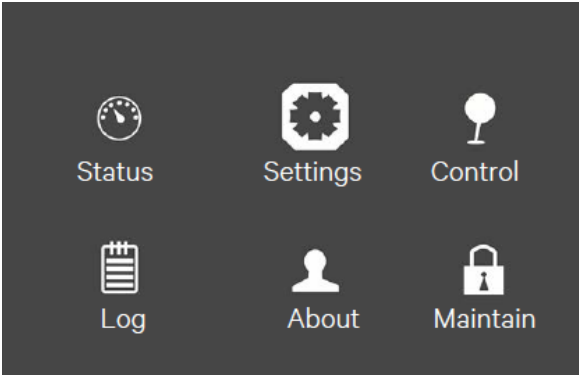



Figure 5-8 Main menu

2. Press the  key to move the cursor to 'Monitor', see Figure 5-9.

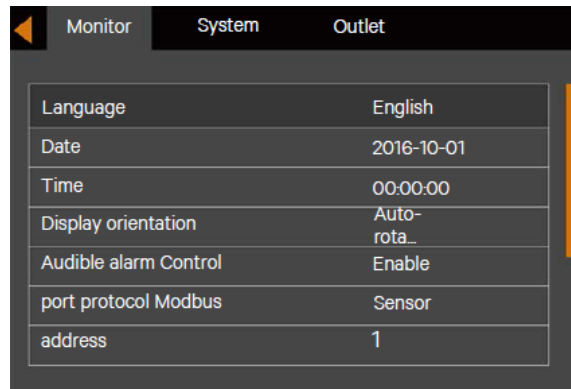



Figure 5-9 Monitor Interface

3. Press the  key to highlight the language, see Figure 5-10.

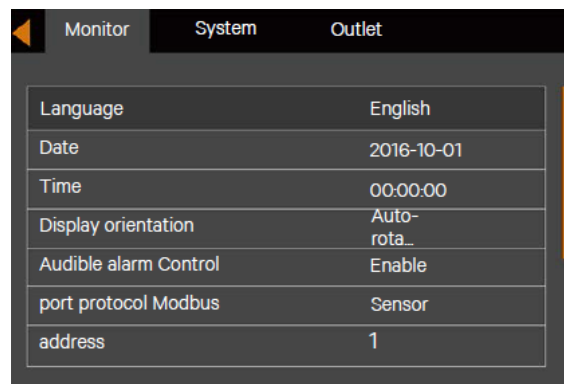





Figure 5-10 Language Selection

4. Press the  or  key to select the language you need, then press the  key to confirm it. At this time, the LCD contents will be the language selected by you. See Figure 5-11.

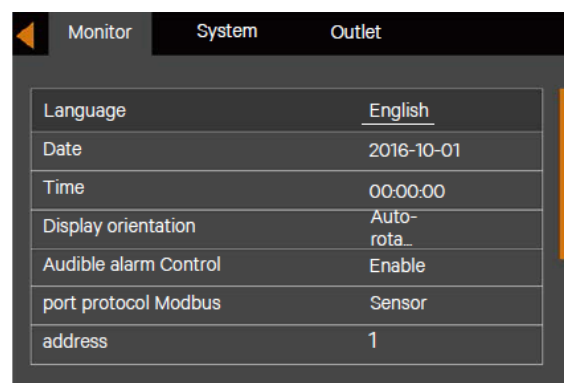





Figure 5-11 Changing Language

5. Press the  key for several times to back to the main menu screen.

5.8 Changing Current Date and Time

Procedures for changing the system date and time:

1. At the main menu screen, press the  or  key to switch the cursor to select 'Settings', then press the  key to confirm it. See Figure 5-12.

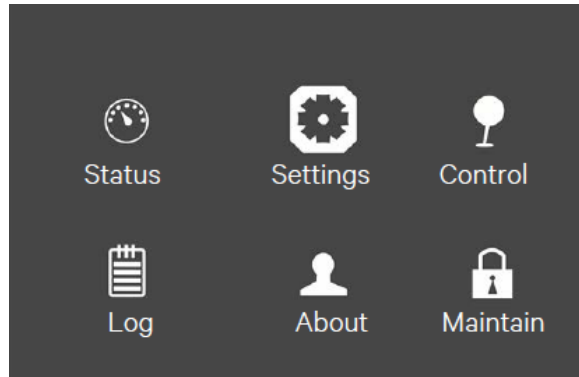



Figure 5-12 Main menu screen

2. Press the  key to move the cursor to 'Monitor', see Figure 5-13.

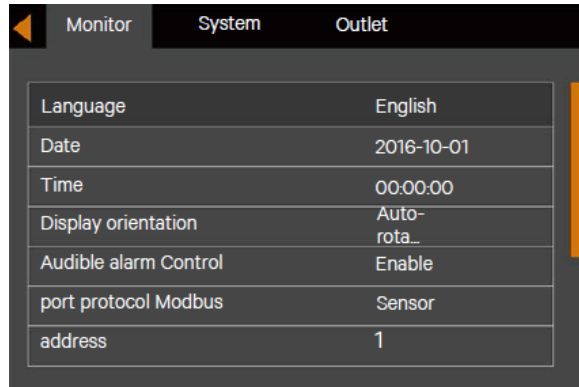

Figure 5-13 Monitor Interface

2. Press the key and press the or key to highlight the date and time, see Figure 5-14.

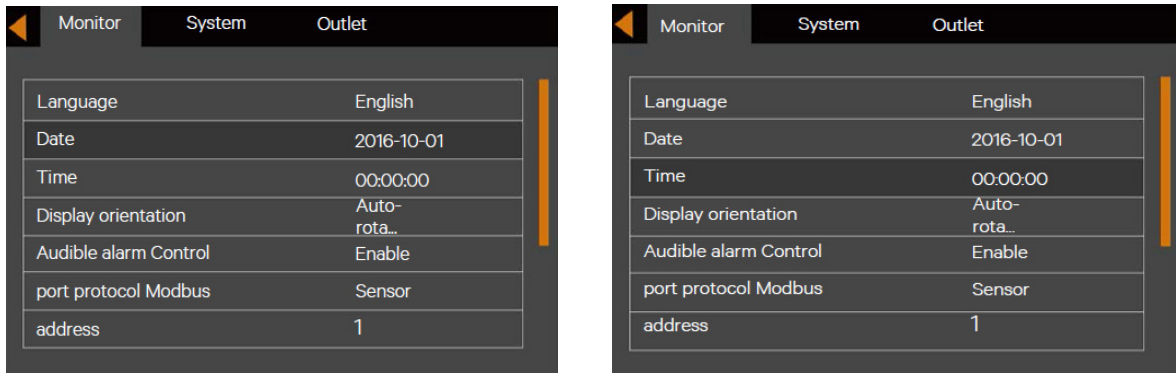

Figure 5-14 Selection of date and time

4. Press the  key, move the cursor and press the  or  key to change the date and time you need. See Figure 5-15.

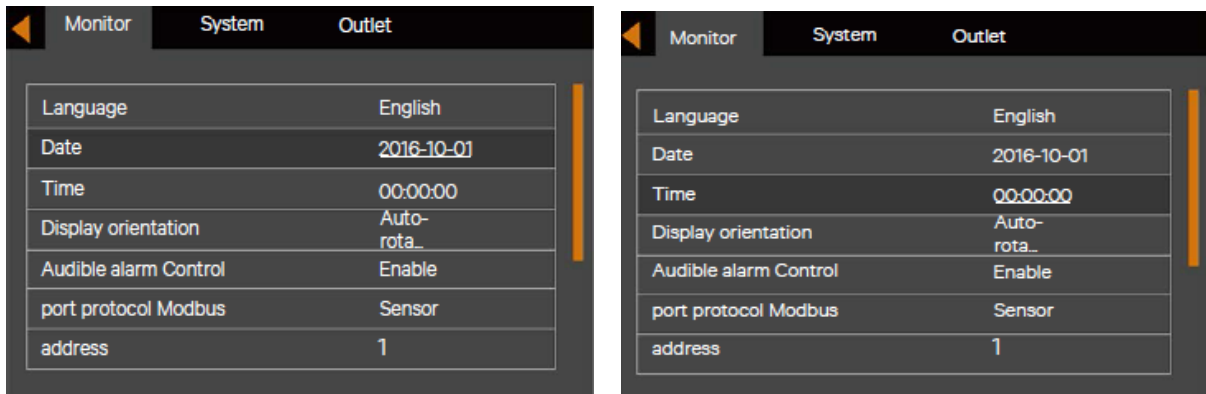



Figure 5-15 Changing date and time

5. Press the  key to confirm it, and then press the  key several times to back to the main menu screen.

5.9 Setting Password

1. After powering on the UPS, at the main menu screen, press the  or  key to move the cursor to select 'Settings'. See Figure 5-16.

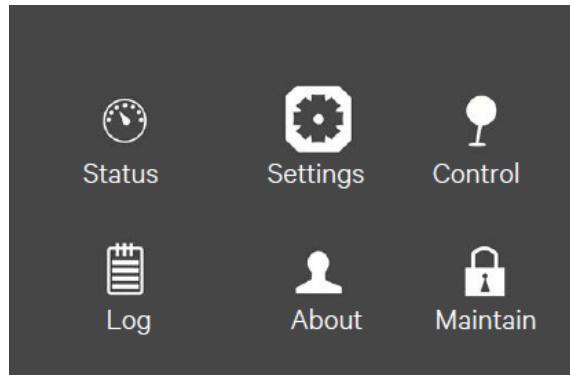



Figure 5-16 Main menu

2. Press the  key, the interface shown in Figure 5-17 will appear.

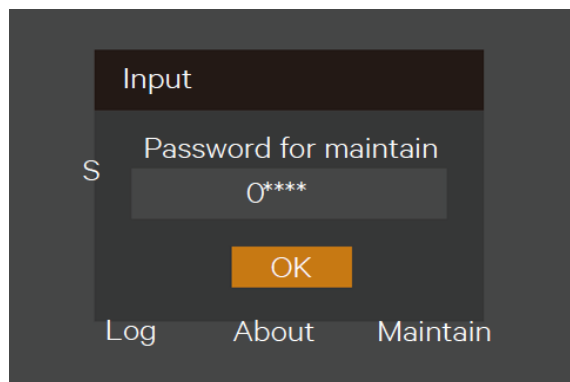



Figure 5-17 Inputting password

The user can observe the following procedures to change password:

1. Press the  key to move the cursor to the 'Monitor', see Figure 5-18.

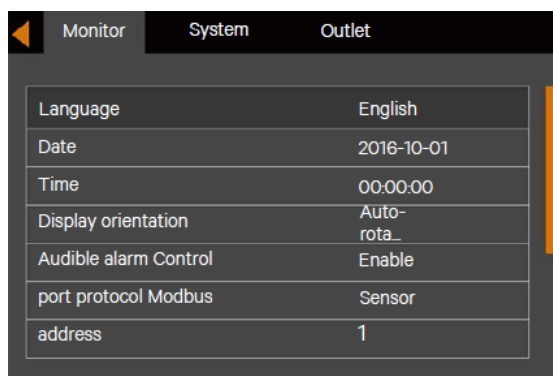

Figure 5-18 Monitor Interface

2. Press the key, then press the key to select the 'Change settings password', see Figure 5-19.

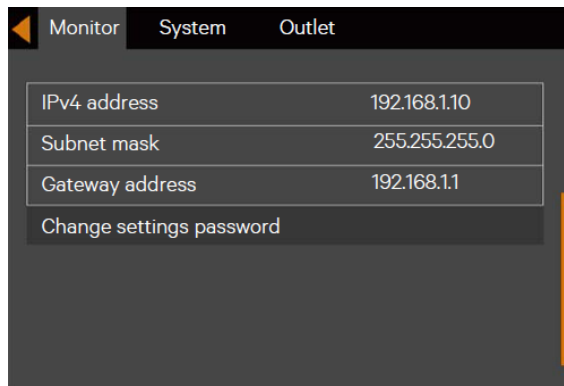



Figure 5-19 Changing setting password

3. Press the  key, the interface shown in Figure 5-20 will appear.

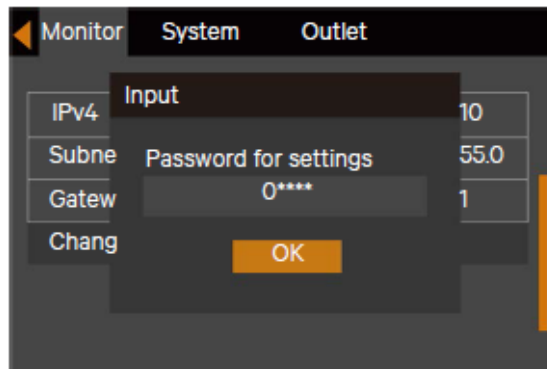



Figure 5-20 Password for settings

4. Input the existing password, press the  key to confirm it, then the system requires to input a new password. See Figure 5-21.

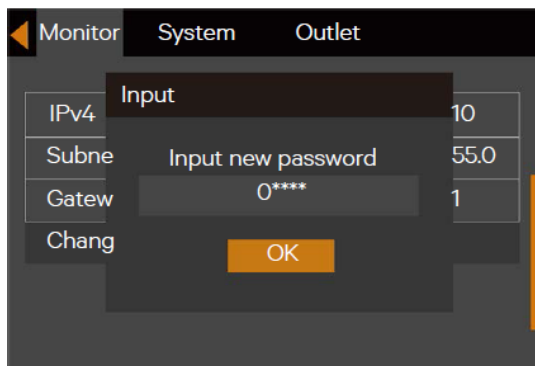



Figure 5-21 Inputting new password

5. After inputting the new password, press the  key to confirm it, then the system requires confirming the new password, see Figure 5-22.

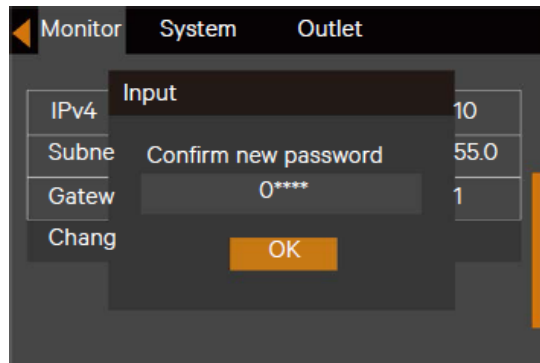



Figure 5-22 Confirming new password

6. After the confirmation, press the  key and the system prompts that the password changing is successful, see Figure 5-23.

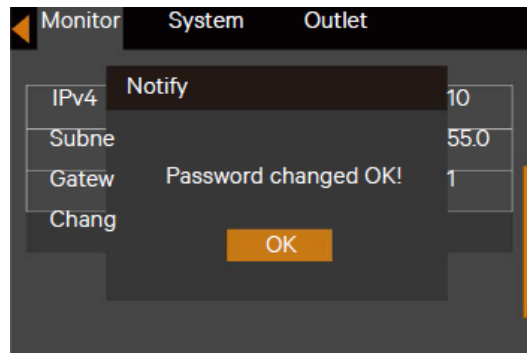

Figure 5-23 Password changed ok

 **Note**

Only through the correct password (default: 111111) verification can you conduct the parameters of the UPS.

Chapter 6 Communication

This chapter briefly introduces the UPS communication.

The communication ports include: intelligent card port, dry contact port, built-in port, 32 port, control port and USB port



It is recommended to make the signal cable length be less than 3m and keep away from the power cable.

6.1 Installing Intelligent Card

6.1.1 Intelligent Card Port

UPS provides an intelligent card port (see Figure 6-1), which is used to install the communication device options, including SIC card and RDU-SIC card. The intelligent card port and USB port can be used at the same time.

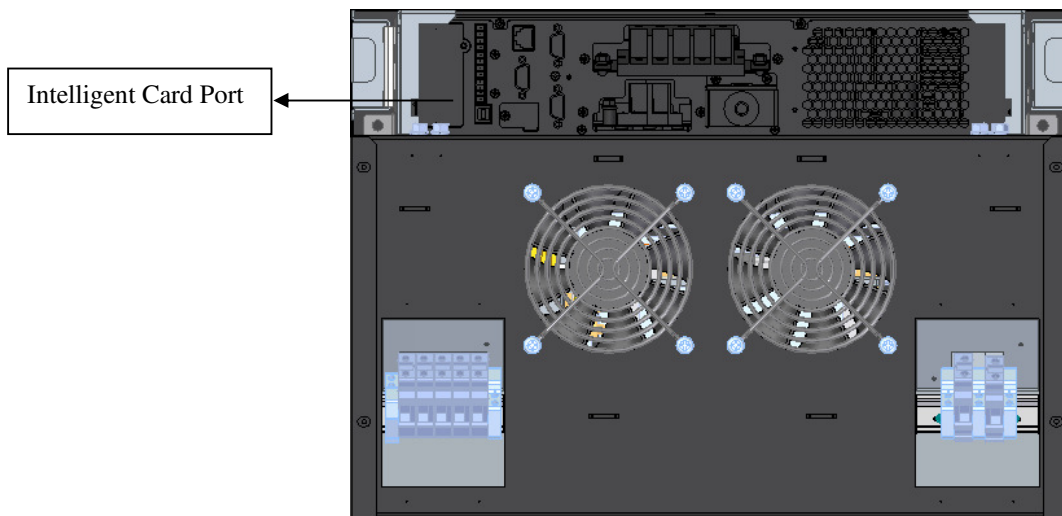

Figure 6-1 Intelligent card installation

6.1.2 Intelligent Card Option

SIC card

SIC card is a network management card, which makes the intelligent devices (such as UPS, air conditioner, static transfer system (STS), sever power management system (SPM), and so on) produced by Vertiv have network communication capability. The SIC card can also be used with the Network Shutdown designed by Vertiv to provide safe automatic shutdown function for the computer, in which the Network Shutdown has been installed, to protect data and reduce loss.

Refer to the corresponding user manual for the installation and operation guide.

RDU-SIC card

The RDU-SIC card is a network management card. It can make the intelligent equipment (such as UPS, PDU and so on) developed by Vertiv have the capacity of network communication. The SIC card can also connect to the environment monitoring equipment, including IRM series or 1-Wire series temperature sensor, temperature & humidity sensor or dry contact signal input & detecting sensors. In case of an intelligent equipment alarm, it notifies the user by multiple ways: recording, sending a Trap message, sending an E-Mail or sending an SMS.

The RDU-SIC card provides four approaches to monitor the intelligent equipment and equipment room environment:

- Web browser. Monitor your intelligent equipment and equipment room environment through the Web server function provided by the SIC card
- Network management system (NMS). Monitor your intelligent equipment and equipment room environment through the SNMP agent function provided by the SIC card
- RDU-Manager. RDU-Manager is a piece of management software for equipment room. You can use RDU-Manager to monitor your intelligent equipment and equipment room environment through the TCP/IP interface provided by the SIC card
- Centralized management software (Nform). Monitor your intelligent equipment through the Velocity Server service function provided by the SIC card

The SIC card can also work with the Network Shutdown computer safe shutdown program developed by Vertiv to provide automatic safe shutdown function for your computer installed with Network Shutdown, so as to prevent data loss.

Refer to the corresponding user manual for the installation and operation guide

RS485 card

RS485 card should be used together with Power bank 600 Model provided by Vertiv to realize the signal transform from RS232 to RS485.

Refer to the corresponding user manual for the installation and operation guide.

RS232 card

The RS232 card should be used together with the Power Bank 600 series UPS of Vertiv. It only supports RS232 protocol communication, and the maximum length of the communication cable cannot exceed 15 meters.

6.2 Connection Cables for Dry Contact Port

The UPS provides five dry contact ports. The silkprints of the five dry contact ports are 1 ~ 12. The pin layout of each dry contact port is shown in Figure 6-2, and the port description is shown in Table 6-1.

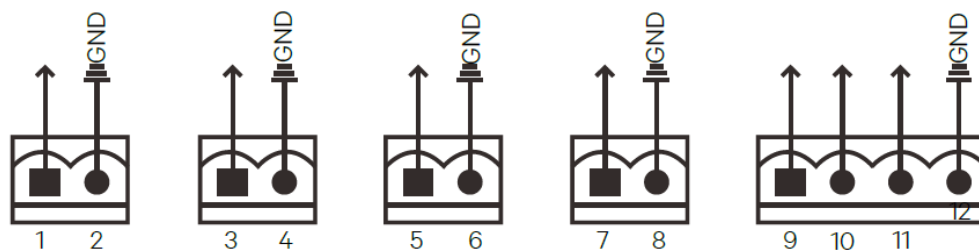

Figure 6-2 Pin layout of dry contact ports

Table 6-1 Description of the dry contact ports

| SilkPrint | Port Name | Pin No | Pin Name | Meaning |
|-----------|------------------|--------|---|---|
| 1 | Output port1 | 1 | LOW-BATTERY/ ON_BATTERY / ON_BYPASS/UPS_FAULT | Default: LOW-BATTERY can be set via the LCD settings page. When the system has as alarm, short Pin 1 and Pin 2 |
| | | 2 | GND | GND |
| 2 | Output Port2 | 3 | LOW-BATTERY/ ON_BATTERY / ON_BYPASS/UPS_FAULT | Default: UPS_FAULT, can be set via the LCD settings page. When the system has as alarm, short Pin 3 and Pin 4 |
| | | 4 | GND | GND |
| 3 | Input port 1 | 5 | Battery mode shutdown/Any mode shutdown (Remote Comms Shutdown)/maintain mode | Default: Maintain mode, can be set via the LCD settings page. When Pin 5 and Pin 6 are shorted, the function is valid |
| | | 6 | GND | GND |
| 4 | Input port 2 | 7 | Battery mode shutdown/Any mode shutdown (Remote Comms Shutdown)/Maintain mode | Default: Maintain mode, can be set via the LCD settings page. When Pin 7 and Pin 8 are shorted, the function is valid |
| | | 8 | GND | GND |
| 5 | REPO input port* | 9 | +5V | REPO power supply, 5Vdc 100mA |
| | | 10 | REPO Coil -NC | NC, ECO activated when Pin 9 and Pin 10 opened |
| | | 11 | REPO Coil -NO | Trigger REPO when Pin 11 and Pin 12 closed |
| | | 12 | GND | REPO Ground |



Note

The I/O dry contact port capacity: 125Vdc, 0.5A; 30Vdc, 1A. Pin11 and Pin12 reserves the corresponding terminals for configuring the REPO function. The REPO device also needs the shielded cable to connect to the Normally Open remote REPO switch between the two terminals. If not necessary, you should disconnect Pin9 and Pin10. Pin9 and Pin10 have been shorted before delivery.



Note

The EPO action of the UPS will close the rectifier, inverter and static bypass, but it cannot disconnect the UPS mains input inside. If you want to disconnect the UPS completely, just disconnect the upstream input MCB when generating the EPO.

In emergency conditions, close the REPO switch (prepared by users) to shut down the rectifier and inverter, and the UPS is powered off. In normal condition, the REPO switch cannot cut off the UPS input power. If a switch of electronic control tripping function is adopted at the UPS input, the REPO switch can help the switch trip and thus cut off the UPS input power. The position of the REPO switch is shown in Figure 1-3, and the REPO cable connection is shown in Figure 6-3.

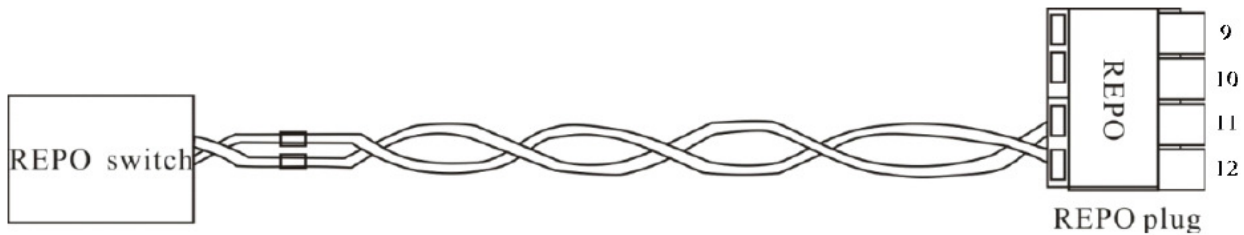

Figure 6-3 Repo cable connection

The cable connection procedures are as follows:

1. Loosen the '11' and '12' connection terminals of the REPO port.
2. Insert the two ends of the copper core cables with the insulation leather peeled into the '11' and '12' connection terminals of the REPO port and press down the terminals. The REPO cable is complete. Ensure that the REPO cable is firmly connected to avoid no action or wrong action of the REPO caused by accidental dropping or infirm contact.
3. For parallel UPSs, when connecting the REPO cable, users should parallel connect '11' of the REPO port with one end of the electronic switch, and parallel connect '12' with the other end of the electronic switch.

When the REPO switch at the user end closes, the UPS will generate an alarm and cut off the output immediately, and the UPS will not return to the normal operation state automatically. At this point, you must change the REPO switch state, and power on the UPS manually.



Note

1. It is recommended to use 0.82mm² ~ 0.33mm² (signal cable of 18AWG ~ 33AWG) copper core cable.

2. If the switch you have configured is of electronic control tripping function, when the REPO signal takes action, you need to close the switch before restart the UPS.

6.3 Connecting USB

The methods to connect the USB communication cable are as follows:

Insert one end of the USB communication cable to the USB port (see Figure 1-3) on the rear panel of the UPS and connect the other end to the USB port of the computer. After the connection, you need to install the USB drive program in the installation disk.

6.4 Connecting Serial Port Communication Cables

The methods to connect the serial port communication cable are as follows:

Insert one end of the DB9 serial port communication cable to the DB9 serial port (see port 5 in Figure 1-3) on the rear panel of the UPS and connect the other end to the DB9 port of the computer.

The pin function of DB9 is listed below:

| Pin No | Function |
|--------|-----------------|
| 2 | Send Data |
| 3 | Receive Data |
| 5 | Common Terminal |

6.5 Connecting Control Port

The control port adopts the standard RJ45 port, which supports the Modbus/Jbus port and connects the Vertiv temperature/temperature & humidity sensor.

The user can select Modbus/Jbus protocol function or sensor function via the 'Settings' on the LCD.

6.6 Connecting Built-In Ethernet Port

The built-in Ethernet port supports the HTTP protocol. The user can connect one end of the net cable to the Ethernet port of the UPS and connect the other end to the built-in Ethernet port of the computer. The user can remotely access the UPS via the IE, Chrome and Firefox, so as to monitor the UPS in real time.

Connect net cables: Connect one end of the net cable to the Ethernet port of the UPS and connect the other end to the built-in Ethernet port (or the switch port, Router port) of the computer.

Set network parameters: The user should change the parameters (IP address, subnet mask, gateway address) of the computer or the UPS, so as to make the computer communicate the UPS well.

To change the network parameters of the UPS, operate them via the 'Settings'->'Monitor', as shown in Figure 6-4.

Webpage monitoring function

Open the browser (like IE), input the IPv4 address at the address bar to the login interface.

After inputting the correct user name and password (default name: user, password: 111111), you can monitor the UPS working status.

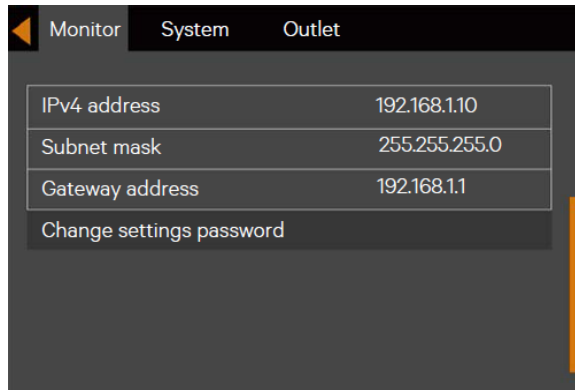

Figure 6-4 Changing UPS Network Parameters

Browser support

To obtain the best user experience, it is recommended to use the Internet Explorer (IE9 or above), or the Chrome, FireFox (latest version required)

Screen resolution

The display with resolution of 1024*768 or above is recommended.

Chapter 7 Maintenance

This chapter focuses on the UPS maintenance, including the fan maintenance, battery maintenance, UPS cleaning, UPS state check, UPS function check



Note

Never maintain the UPS on line. Ensure that the UPS has been completely powered off when performing the UPS Internal maintenance.

7.1 Fan Maintenance



Note

Before the fan is completely stopped, do not insert your fingers or some tools into the fan so as to avoid device damage or personal injury.

The UPS fans are expected to run for 20000 hours ~ 40000 hours continuously. The higher the ambient temperature, the shorter the fan life is.

During the UPS operation, please verify the fan status once every half year by confirming that air blows out from the ventilation holes on the rear panel.

7.2 Battery Maintenance



Note

- 1. Never reverse-connect the battery, otherwise the fire will occur.*
- 2. Never open the battery to prevent physical injury because of the electrolyte. If you accidentally touch the electrolyte, wash the area immediately with plenty of clean water and go to hospital.*

The internal battery module of the UPS is sealed, lead-acid, maintenance-free battery. The battery life depends on the ambient temperature, charge and discharge times. High ambient temperature and deep discharge shortens the battery life.

To ensure the battery life, it is required to:

- Keep the ambient temperature ranging from 15°C to 25°C
- Prevent small current discharge. Continuous battery operation time exceeding 24 hours is strictly prohibited
- Charge the battery for at least 12 hours, if the battery hasn't been charged for three months at specified ambient temperature, or two months at high ambient temperature

**Note**

1. Check regularly the screws at the battery connection parts, fasten it immediately if not tight.
2. Make sure that the safety equipment is complete and that the function is normal, especially that the settings of the battery management parameters are normal.
3. Measure and record the internal temperature of the battery room.
4. Check whether the battery ports are damaged or hot, and whether the chassis and the covers are damaged

If liquid leakage and damage to the battery are found, place the battery in the anti-vitriol tank, and deal with it according to the local regulations.

The waste lead-acid battery is dangerous waste material. It is one of the national emphases to control the waste battery pollution. Its storage, transportation, usage and disposal must follow the national and local law and other criterions about the dangerous waste material and the waste battery pollution prevention.

According to the related regulations, recycle the waste lead-acid battery, and other disposal methods are prohibited. Throwing away randomly the waste lead-acid battery and other improper disposal methods can result in serious environment pollution, which will be investigated the legal responsibility.

As the provider of the lead-acid battery, Vertiv has built perfect service network and recycle system for the waste battery to assist users to deal with the waste battery by law. Contact Vertiv or the nearest service center for the detailed information of the recycle system about the waste battery.

Vertiv is not liable for the environment results caused by failure to comply with the notices in this section or to use the waste battery recycle system provided by Vertiv.

7.3 Cleaning UPS

Clean the UPS periodically, especially the ventilation holes, to ensure free airflow inside the UPS. If necessary, clean the UPS with a vacuum cleaner. Confirm that the ventilation holes are unobstructed.

7.4 Checking UPS Status

**Note**

UPS functions check procedures may cause power interruption to load!

It is recommended to check the UPS operation status once every half year.

Check the following items:

1. Check if the UPS is faulty: Is the alarm indicator on? Is the UPS giving any alarm?
2. Check if the UPS is operating in Bypass mode. Normally, the UPS operates in Normal mode; if it is operating in Bypass mode, you should find out the reason, such as operator intervention, overload, internal fault, and so on.

3. Check if the battery is discharging: When AC mains is normal, the battery should not discharge; if the UPS operates in Battery mode, you should find out the reason, such as mains failure, battery test, operator intervention, and so on.

7.5 Checking UPS Function

It is recommended to check the UPS functions once every half year. Backup the load data before conducting the UPS functions check. Procedures are as follows:

1. Press the power button to check if the buzzer beeps, indicators are on and the LCD display is normal.
2. Press the ESC key to check again if the indicators are on, the LCD display is normal, and the UPS has been transferred to the inverter mode.

Chapter 8 Options

The Chapter introduces the options of the UPS.

8.1 Option List

Table 8-1 Option list

| No. | Option name | Remark | Model |
|-----|-----------------|--------------------|--------------|
| 1 | Parallel Cables | 2M Parallel Cable | 324922020702 |
| 2 | | 3M Parallel cable. | 324922020703 |
| 3 | | 5M Parallel Cable | 324922020706 |
| 4 | SNMP | | 931602351817 |
| 5 | RDU SIC Card | | 931602311887 |

8.2 Communication Cables

Communication cable is compulsory in parallel system. See Table 8-2 for cable description. Refer to 3.4.2 Connecting Parallel Cables for the methods to connect the parallel cables.

Table 8-2 Parallel Cables

| Type | Name | Description | Appearance |
|--|------------------------------------|--|---|
| 324922020702, 324922020703, 324922020706 | Parallel communication cable | For N + 1 parallel system, N + 1 communication cables (2m, 3m, 5m) are needed. For example, two communication cables are needed in 1 + 1 parallel system; three communication cables are needed in 2 + 1 parallel system; four communication cables are needed in 3 + 1 parallel system |  |

Appendix 1 LCD Parameter Settings

| Menu | Item | Setting Range | Default Setting |
|----------|----------------------------|---|----------------------|
| System | Auto restart | Disable, Enable | Enable |
| | Auto restart delay | 0~999 seconds | 10; Single unit only |
| | Guaranteed shutdown | Disable, Enable | Disable |
| | Remote control | Disable, Enable | Enable |
| | Remote power on delay | 0~999 seconds | 0 |
| | Remote shutdown delay | 0~999 seconds | 0 |
| | Redundant | NO, YES | YES |
| | IT system compatibility | Disable, Enable | Disable |
| | Dry contact 1 (Output) | Low battery, On bypass, On battery, UPS fault | Low battery |
| | Dry contact 2 (Output) | Low battery, On bypass, On battery, UPS fault | UPS Fault |
| | Dry contact 3 (Input) | Battery mode shutdown, Any mode shutdown, Maintain mode | Maintain mode |
| | Dry contact 4 (Input) | Battery mode shutdown, Any mode shutdown, Maintain mode | Maintain mode |
| Output | Voltage selection | 220V, 230V, 240V | 220V |
| | Startup on bypass | Disable, Enable | Disable |
| | Frequency Selection | Auto, BypEna; Auto, BypDisa; 50Hz, BypDisa; 60Hz, BypDisa | Auto, BypEna |
| | Inverter sync range | ±0.5Hz, ±1.0Hz, ±2.0Hz, ±3.0Hz, ±4.0Hz, ±5.0Hz | ±3.0Hz |
| | Bypass voltage upper limit | +10%, +15%, +20% | +20% |
| | Bypass voltage lower limit | -10%, -20%, -30%, -40% | -40% |
| | Bypass frequency range | ±5Hz, ±10Hz | ±10Hz |
| | Run mode | Normal, ECO mode | Normal |
| Menu | Item | Setting Range | Default Setting |
| Output | ECO voltage range | ±5%, ±10%, ±15% | ±10% |
| | ECO frequency range | ±1Hz, ±2Hz, ±3Hz | ±3Hz |
| | ECO | requalification time 5, 15, 30 (min) | 30 |
| | Output phase No. | 1 phase, 3 phases | 1 phase |
| Parallel | Voltage selection | 220V, 230V, 240V | 220V |
| | Frequency selection | Auto, BypEna; Auto, BypDisa; 50Hz, BypDisa; 60Hz, BypDisa | Auto, BypEna |
| | Run mode | Normal, ECO mode | Normal |
| | Redundant | NO, YES | YES |
| | System parallel No. | 1~4 | 1 |
| | Output phase No. | 1 phase, 3 phases | 3 phases (/20kVA) |
| | Sync parallel parameters | Button | Button |
| | Shared battery | Disable, Enable | Disable; /20kVA only |

| | | | |
|---------|--|---|-----------------------------|
| Battery | Local/Parallel battery total Ah | 7~3000Ah | 9Ah (5/6kVA) |
| | External battery cabinet vgroup No. | Auto test, 0~10 | Auto test |
| | Low battery time | 2~30 (min) | 2 |
| | Battery replaced time | YYYY-MM-DD HH:MM:SS | 2000-01-01 0:00:00 |
| | Battery test interval | Disable, 8 weeks, 12 weeks, 16 weeks, 20 weeks, 26 weeks | Disable |
| | Battery test weekday | Sunday, Monday, Tuesday, Wednesday, Thursday, Friday, Saturday | Wednesday |
| | Battery test time | HH:MM:SS | 0:00:00 |
| | Battery series | 6kVA: 12, 16, 20 20kVA: 24, 32, 40 | 16 (6kVA), 32 (20kVA) |
| | Discharge protect time | 1~4320 (min) | 4320 |
| | Equal charge enable | NO, YES | NO |
| | Temperature Compensation | Disable, Enable | Disable |
| | Replace battery | Button | Button |
| Menu | Item | Setting Range | Default Setting |
| Outlet | Turn on outlet | | Appear only when outlet off |
| | Turn off outlet | | Appear only when outlet off |
| | Reboot outlet | | Appear only when outlet off |
| | Turn off when UPS overload on battery | YES, NO | NO |
| | Turn off when UPS on battery for | 0~4320 (min) | 2 |
| | Turn off when backup time less than | 0~4320 (min) | 0 |
| | Turn off when battery capacity less than | 20~80% | 30% |
| | Turn on when power returns for | 0~4320 (min) | |
| MONITOR | Language | English, Chinese | English |
| | Date | YYYY-MM-DD | 2016-10-0 |
| | Time | HH:MM:SS | 00:00:00 |
| | Display orientation | Auto-rotate, horizontal, Vertical | Auto-rotate |
| | Audible Alarm | Disable, Enable | Enable |
| | Control port protocol | Modbus, Sensor | Sensor |
| | Modbus address | 1~128 | 1 |
| | IPv4 address | ddd.ddd.ddd.ddd ('d' is a decimal number) | 192.168.1.10 |
| | Subnet mask | | 255.255.255.0 |
| | Gateway address | | 192.168.1.1 |
| | Change settings password | The password is numeric only and can be set from 0 to 9. The password length is 6 | 111111 |

Appendix 2 Glossary

| | |
|------|------------------------------------|
| AC | Alternating current |
| CB | Circuit breaker |
| CSA | Cross sectional area |
| DC | Direct current |
| DIP | Dual-in-line Package |
| DSP | Digital Signal Processor |
| EMC | Electromagnetic compatibility |
| EMI | Electromagnetic interference |
| EOD | End-of-discharge |
| EPO | Emergency power off |
| I/O | Input/output |
| IGBT | Integrated gate bipolar transistor |
| LBS | Load bus synchronizer |
| LCD | Liquid crystal display |
| LED | Light-emitting diode |
| MCB | Master Circuit Breaker |
| NMS | Network Management System |
| PE | Protective Earth |
| RCCB | Residual current circuit breaker |
| RCD | Residual current detector |
| REPO | Remote emergency power off |
| SCR | Silicon-controlled rectifier |
| SNMP | Simple network monitoring protocol |
| STS | Static transfer switch |
| UPS | Uninterruptible power system |

Appendix 3 Hazardous Substances or Elements Announcement

| Parts | Hazardous substances or elements | | | | | |
|---|----------------------------------|------------|---------|----------|-----|------|
| | Plumbum | Hydrargyru | Cadmium | Chrome6+ | PBB | PBDE |
| | Pb | Hg | Cd | Cr6 + | PBB | PBDE |
| Cables | x | o | o | o | o | o |
| This table is made following the regulation of SJ/T 11364. o: Means the content of the hazardous substances in all the average quality materials of the parts is within the limits specified in GB/T 26572 x: Means the content of the hazardous substances in at least one of the average quality materials of the parts is outside the limits specified in GB/T 26572 | | | | | | |
| Applicable scope: Liebert® Power Bank 600 5~6kVA | | | | | | |